

CITYHALL GROUNDS

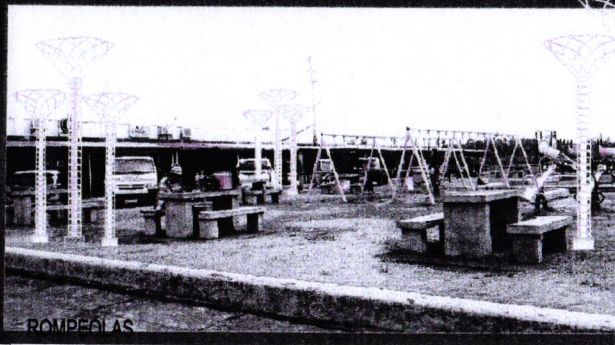

BACON MUNICIPAL HALL

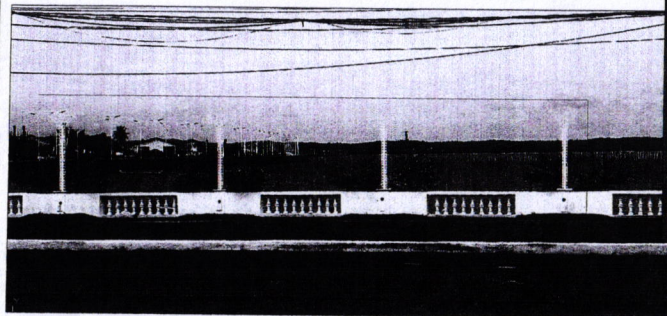

ROMPELAS

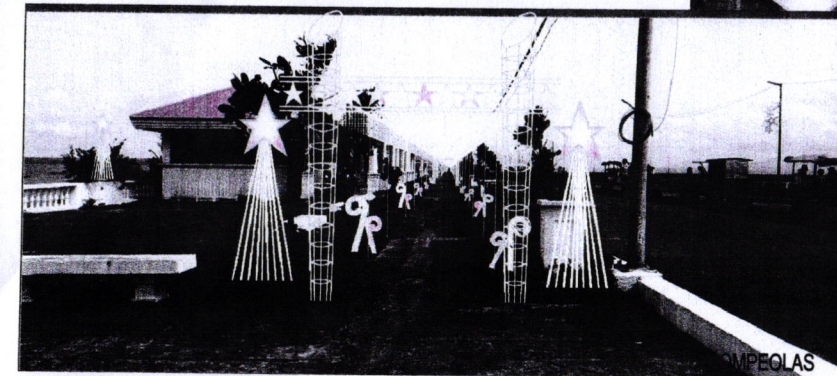

ROMPELAS



CENTER ISLAND

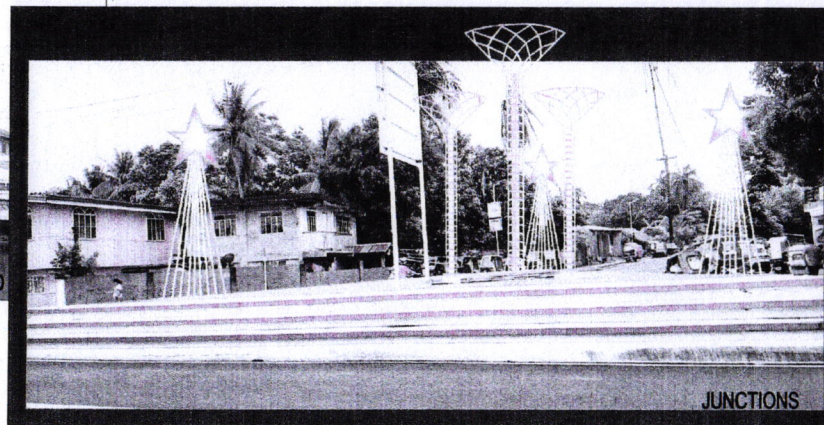

JUNCTIONS

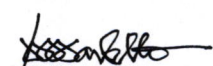
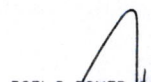
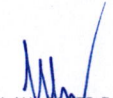
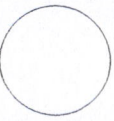

P E R S P E C T I V E

PREPARED FROM:	PROJECT TITLE:	CADD BY:	RECOMMENDED BY:	APPROVED BY:	SHEET NO.
 <p>SORSOGON CITY CITY ENGINEER'S OFFICE</p>	<p>SUPPLY, FABRICATION AND INSTALLATION OF CHRISTMAS DECORATION</p> <p>LOCATION: SORSOGON CITY.</p>	 ROWAN MARBELLA DRAFTSMAN III	 ROEL D. DIMER, C.E./RMP CITY ENGINEER	 HON. MA. ESTER E. HAMOR CITY MAYOR	

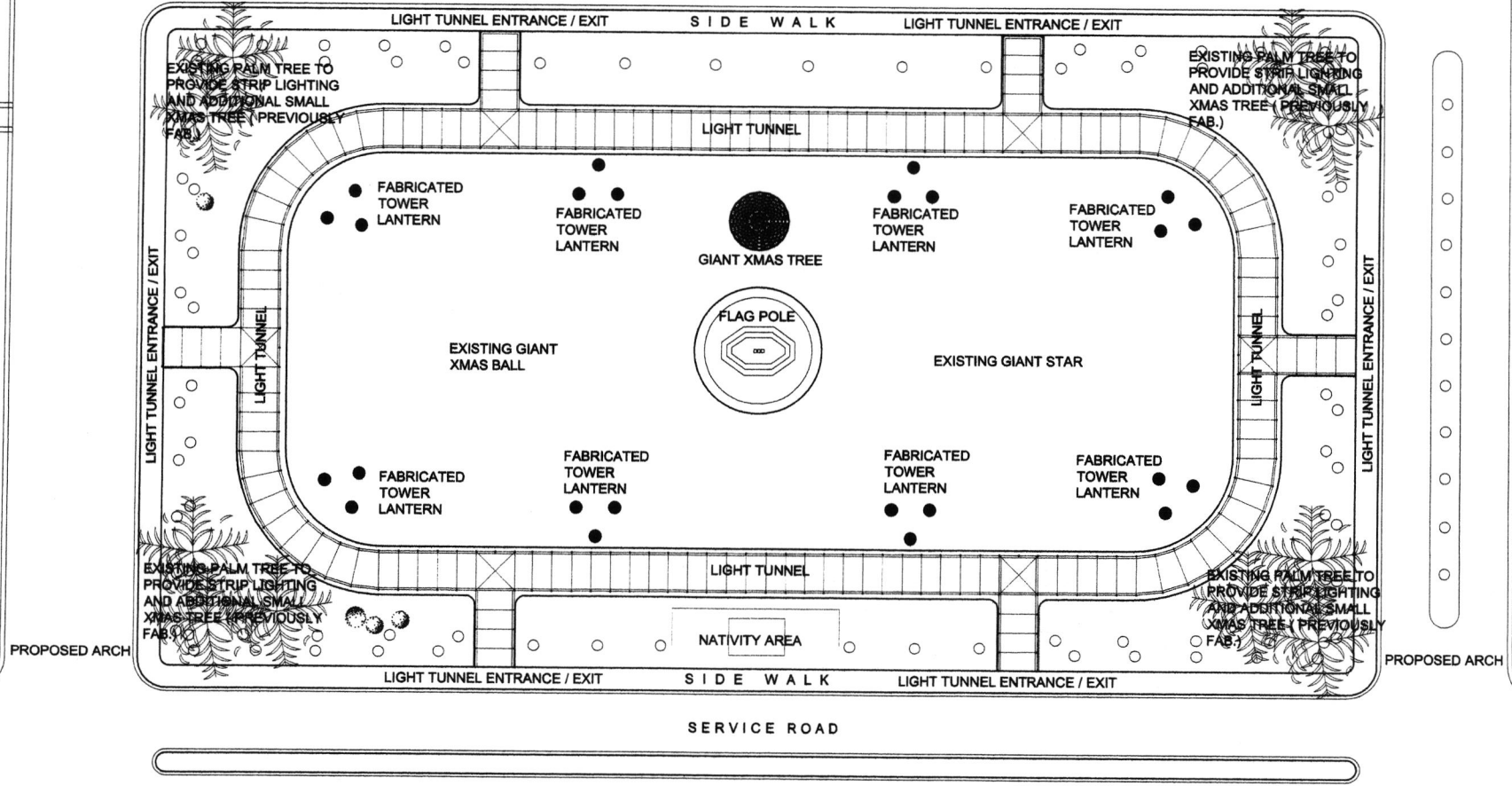
CITY HALL BUILDING

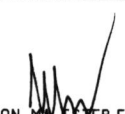
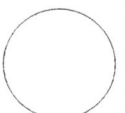

SITE DEVELOPMENT PLAN
SCALE: 1:500M

PREPARED FROM:	PROJECT TITLE:	CADD BY:	RECOMMENDED BY:	APPROVED BY:	SHEET NO.
 SORSOGON CITY CITY ENGINEER'S OFFICE	<p>SUPPLY, FABRICATION AND INSTALLATION OF CHRISTMAS DECORATION</p> <p>LOCATION: SORSOGON CITY.</p>	 ROWAN MARBELLA DRAFTSMAN III	 ROEL D. DOMER C.E./RMP CITY ENGINEER	 HON. MA. ESTER E. HAMOR CITY MAYOR	

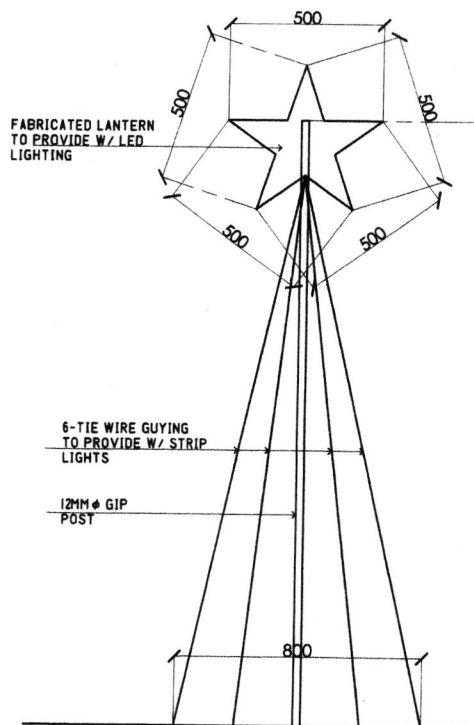

TOWER LANTERN 4 DETAIL
SCALE: 1:18M.

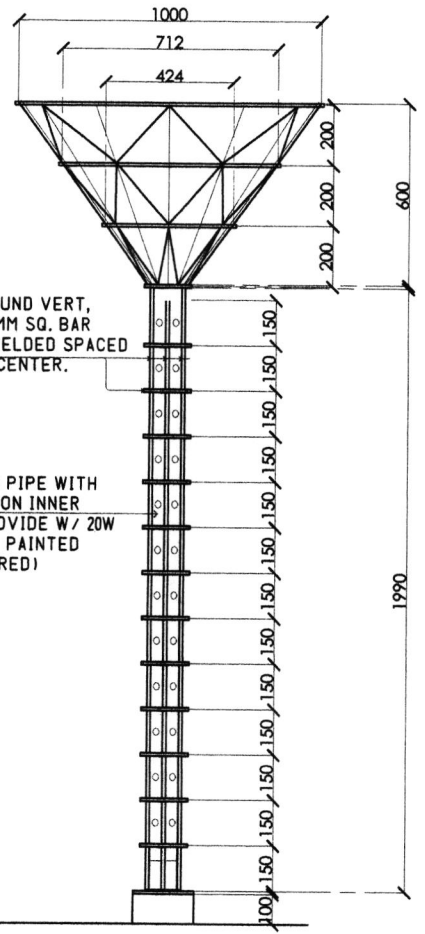

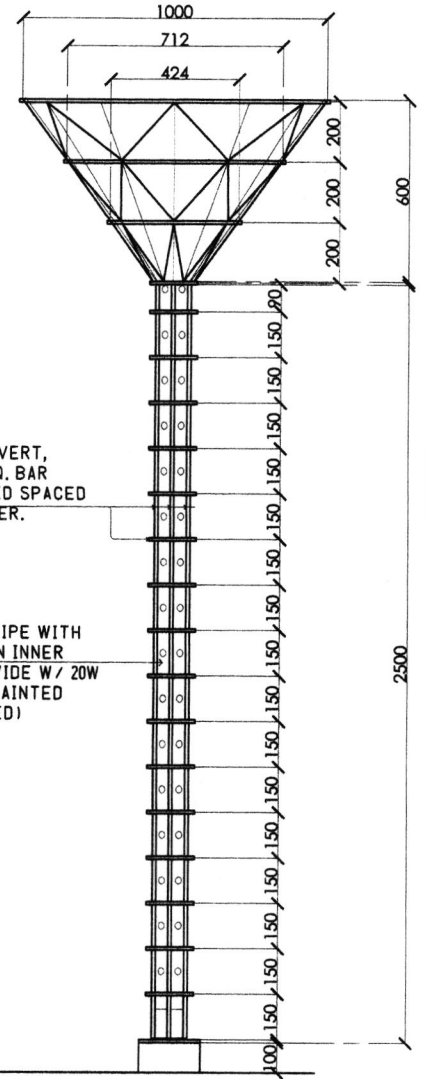

TOWER LANTERN 3 DETAIL
SCALE: 1:18M.

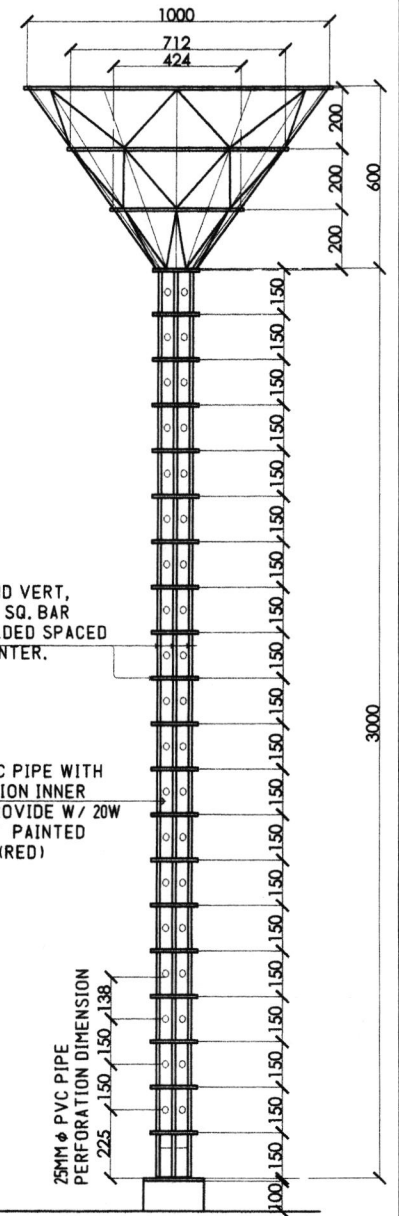

TOWER LANTERN 2 DETAIL
SCALE: 1:18M.

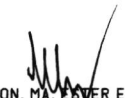
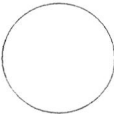

TOWER LANTERN 1 DETAIL
SCALE: 1:18M.

PREPARED FROM:	PROJECT TITLE:	RECOMMENDED BY:	APPROVED BY:	SHEET NO.
 <p>SORSOGON CITY ENGINEER'S OFFICE</p>	<p align="center">SUPPLY, FABRICATION AND INSTALLATION OF CHRISTMAS DECORATION</p> <p>LOCATION: SORSOGON CITY.</p>	<p align="center">  ROWAN MARBELLA DRAFTSMAN III </p> <p align="center">  ROEL D. DUMPER CITY ENGINEER </p>	<p align="center">  HON. MA. EVER E. HAMOR CITY MAYOR </p>	

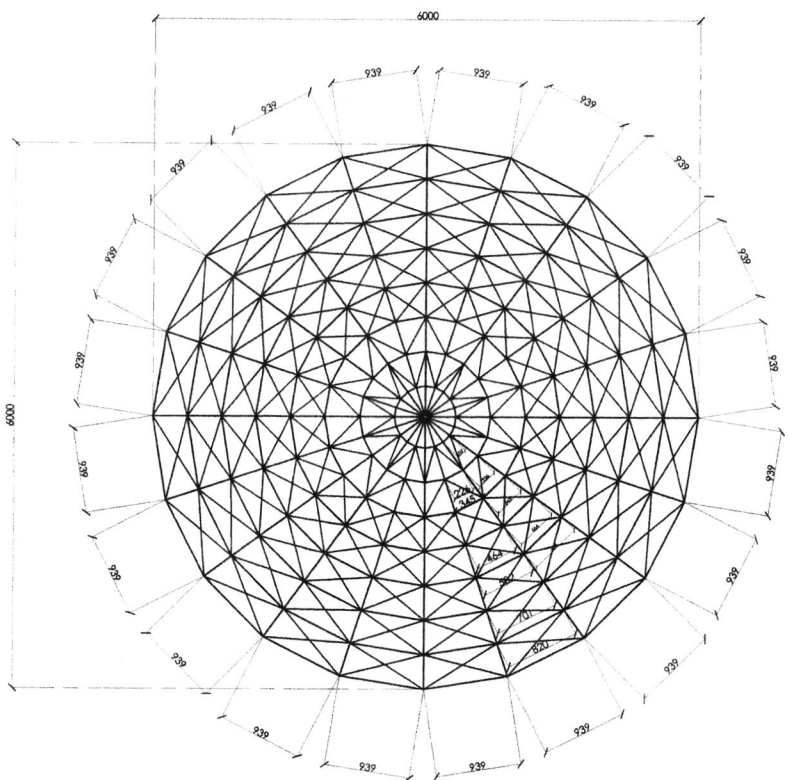

PLAN

GIANT CHRISTMAS TREE
SCALE: 1:60M.

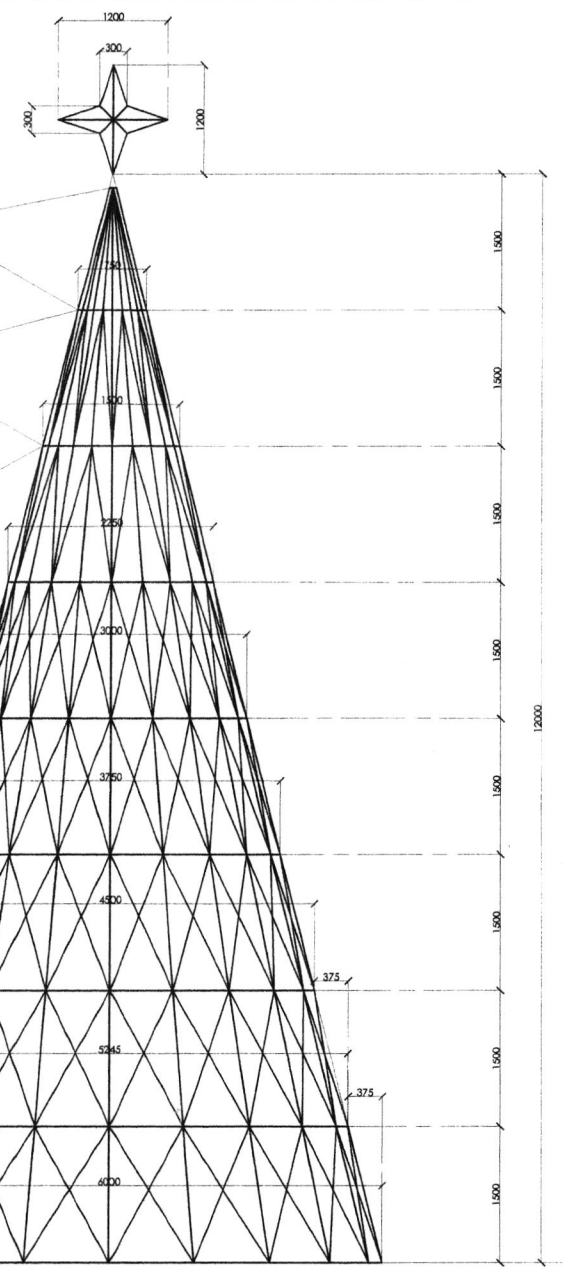

10MM ϕ MAIN SQ. BAR
TOP AND BOTTOM
POLYGONAL FRAMING W/
10MM ϕ SQ. BAR VERT
SUPPORT AND 10MM ϕ SQ.
BAR DIAG. SUPPORT

18MM ϕ MAIN GIP TOP
AND BOTTOM
POLYGONAL FRAMING W/
12MM ϕ GIP VERT
SUPPORT AND 10MM ϕ SQ.
BAR DIAG. SUPPORT

25MM ϕ MAIN GIP TOP
AND BOTTOM
POLYGONAL FRAMING
W/ 10MM ϕ GIP VERT
SUPPORT AND 12MM ϕ
GIP DIAG. SUPPORT

36MM ϕ MAIN GIP TOP
AND BOTTOM
POLYGONAL FRAMING
W/ 25MM ϕ GIP VERT
SUPPORT AND 12MM ϕ
GIP DIAG. SUPPORT

50MM ϕ MAIN GIP TOP
AND BOTTOM
POLYGONAL FRAMING
W/ 38MM ϕ GIP VERT
SUPPORT AND 12MM ϕ
GIP DIAG. SUPPORT

SECTIONAL ELEVATION

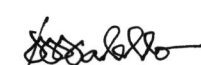
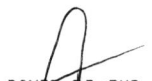
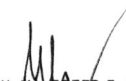
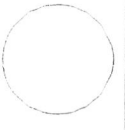
PREPARED FROM:	PROJECT TITLE:	CADD BY:	RECOMMENDED BY:	APPROVED BY:	SHEET NO.
	<p align="center">SUPPLY, FABRICATION AND INSTALLATION OF CHRISTMAS DECORATION</p> <p>LOCATION: SORSOGON CITY.</p>	<p align="center">  ROWAN MARBELLA DRAFTSMAN III </p>	<p align="center">  ROEL D. DOMEZ CITY ENGINEER </p>	<p align="center">  HON. MAYOR E. HAMOR CITY MAYOR </p>	

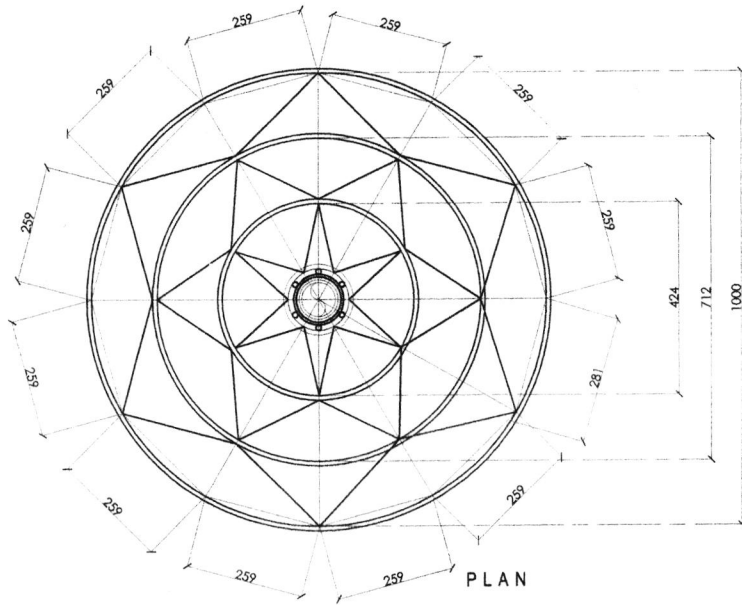

PLAN (TOWER LANTERN)

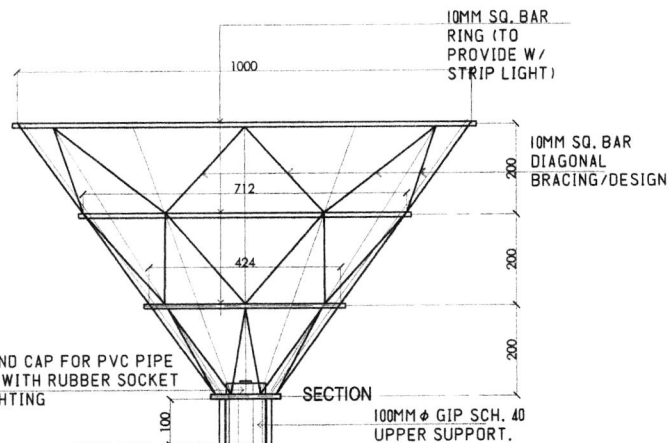

SECTION (TOWER LANTERN)

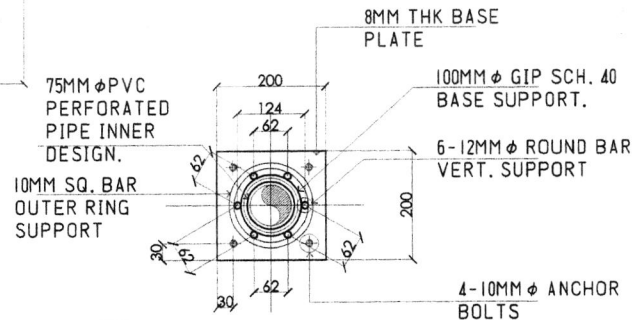

BASE PLATE PLAN

SCALE: 1:10M.



TOWER LANTERN DETAIL

SCALE: 1:12M.

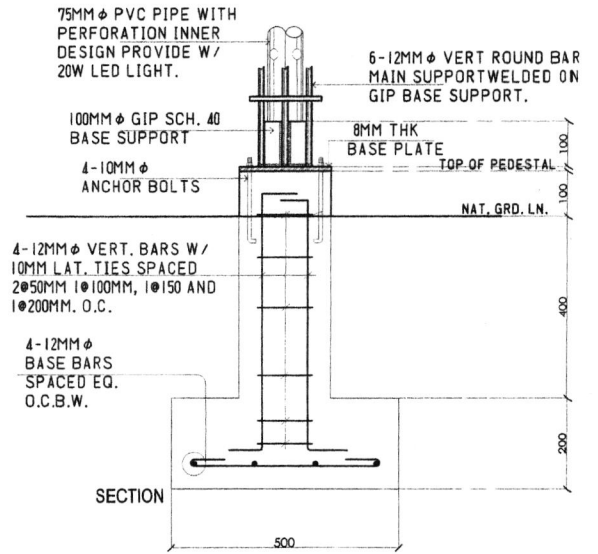

SECTION

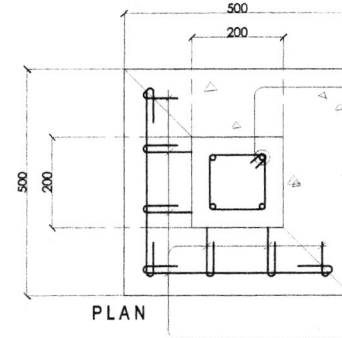

PLAN

PEDESTAL/FOOTING DETAIL

SCALE: 1:12M.

PREPARED FROM:

PROJECT TITLE:

CADD BY:

RECOMMENDED BY:

APPROVED BY:

SHEET NO.

**SUPPLY, FABRICATION AND INSTALLATION
OF CHRISTMAS DECORATION**

LOCATION: SORSOGON CITY.

ROWAN MARBELLA
DRAFTSMAN III

ROEL D. DOMER, C.E./RMP
CITY ENGINEER

HON. MA. EDNER E. HAMOR
CITY MAYOR