

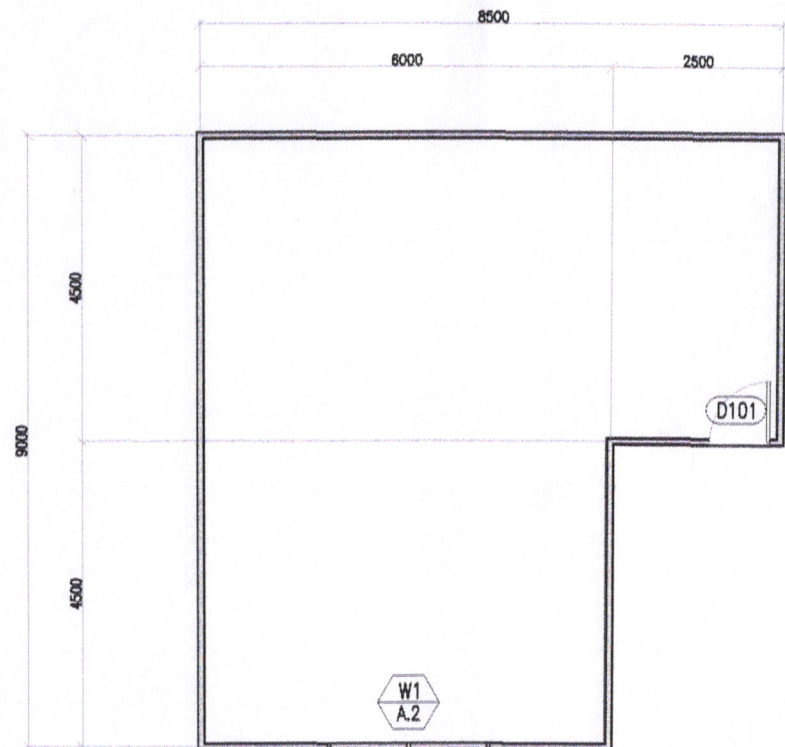

1 FLOOR PLAN (EXISTING)
A-1 SCALE 1/100



2 FLOOR PLAN (PROPOSED)
A-1 SCALE 1/100

PREPARED FROM:	PROJECT TITLE:	DRAWN:	RECOMMENDED BY:	APPROVED BY:	SHEET NO.
 <p>SORSOGON CITY ENGINEER'S OFFICE</p>	<p>REPAIR AND IMPROVEMENT OF EMERGENCY OPERATION CENTER</p> <p>LOCATION: BRGY. CABID-AN, SORSOGON CITY, SORSOGON</p>	<p><i>maria lara j. makabuena, uap</i></p> <p>ARCHITECT I</p>	<p>ROEL D. DOMER C.E.</p> <p>CITY ENGINEER</p>	<p><i>[Signature]</i></p> <p>HON. MA. ESTER E. HAMOR</p> <p>CITY MAYOR</p>	<p>4</p> <p>A.1</p>

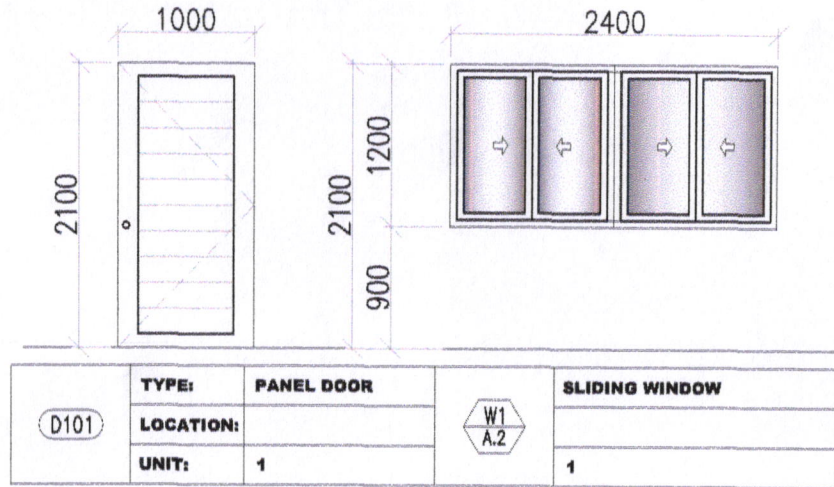

1 DOOR AND WINDOW SCHEDULE
SCALE 1/50

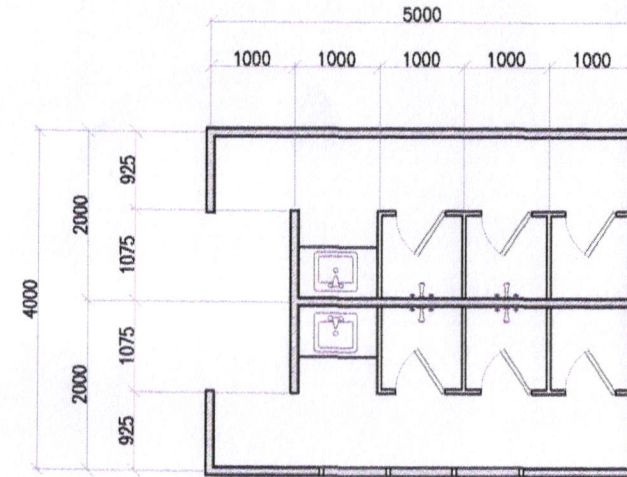

3 FLOOR PLAN (EXISTING)
SCALE 1/100

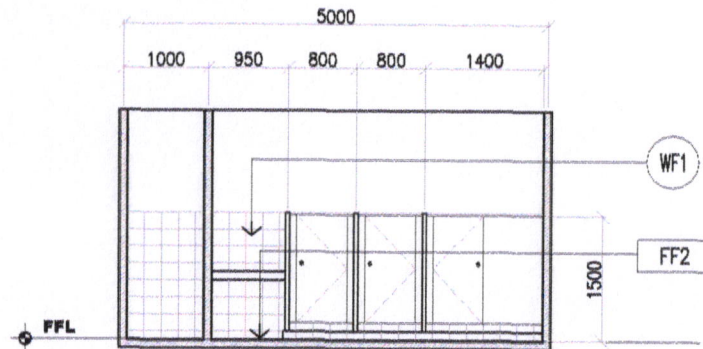

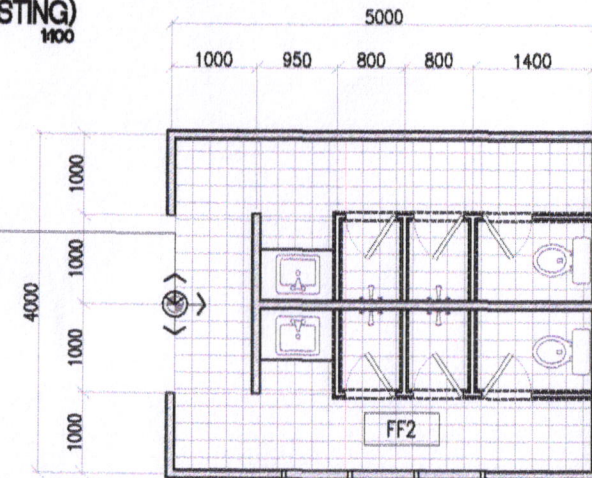

2 ELEVATION
SCALE 1/100

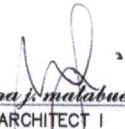

4 FLOOR PLAN (PROPOSED)
SCALE 1/100

LEGEND:	
FF1	400MM X 400MM CERAMIC TILES (GLOSS FINISH)
FF2	200MM X 200MM CERAMIC TILES (MATTE FINISH)
WF1	200MM X 400MM CERAMIC TILES (MATTE FINISH)

PREPARED FROM:	PROJECT TITLE:	DRAWN:	RECOMMENDED BY:	APPROVED BY:	SHEET NO.
 SORSOGON CITY CITY ENGINEER'S OFFICE	REPAIR AND IMPROVEMENT OF EMERGENCY OPERATION CENTER	 maria lara j. malabuena, uap ARCHITECT I	ROEL D. DOMER C.E. CITY ENGINEER	 HON. MA. ESTER E. HAMOR CITY MAYOR	4 A.2
	LOCATION: BRGY. CABID-AN, SORSOGON CITY, SORSOGON				

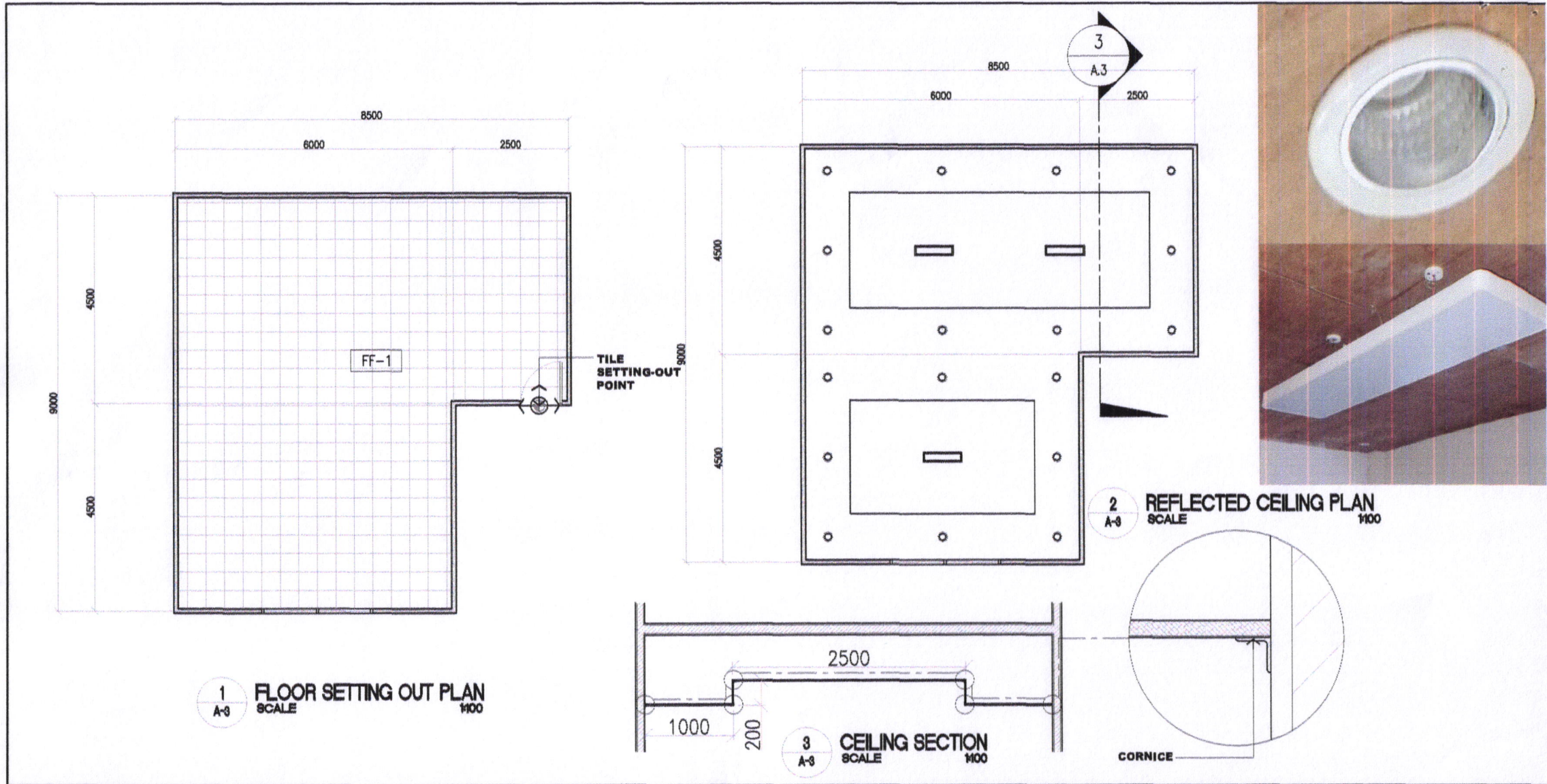

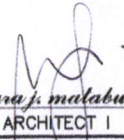
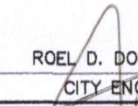
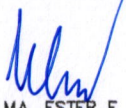
PREPARED FROM:	PROJECT TITLE:	DRAWN:	RECOMMENDED BY:	APPROVED BY:	SHEET NO.
 SORSOGON CITY CITY ENGINEER'S OFFICE	REPAIR AND IMPROVEMENT OF EMERGENCY OPERATION CENTER LOCATION: BRGY. CABID-AN, SORSOGON CITY, SORSOGON	 <i>maria lara j. malabuena, uap</i> ARCHITECT I	 ROEL D. DOMER C.E. CITY ENGINEER	 HON. MA. ESTER E. HAMOR CITY MAYOR	<div style="border: 1px solid black; border-radius: 50%; width: 40px; height: 40px; display: flex; align-items: center; justify-content: center;"> <div style="border-bottom: 1px solid black; width: 100%; text-align: center;">4</div> <div style="width: 100%; text-align: center;">A.3</div> </div>

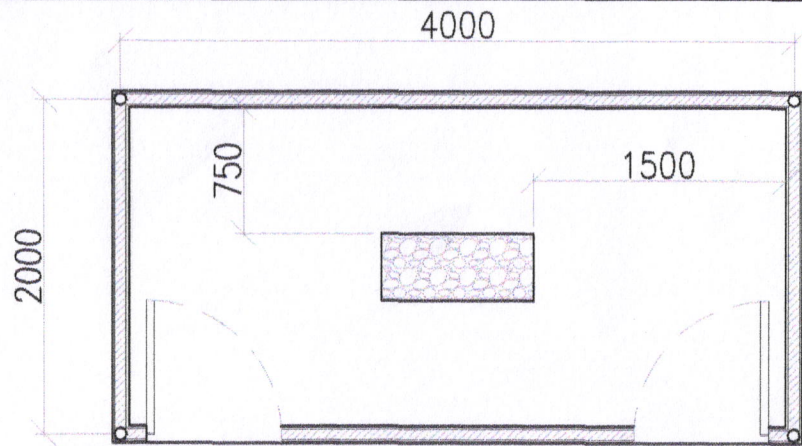

1 FLOOR PLAN (GENSET SHED)
SCALE 1/40
A-4

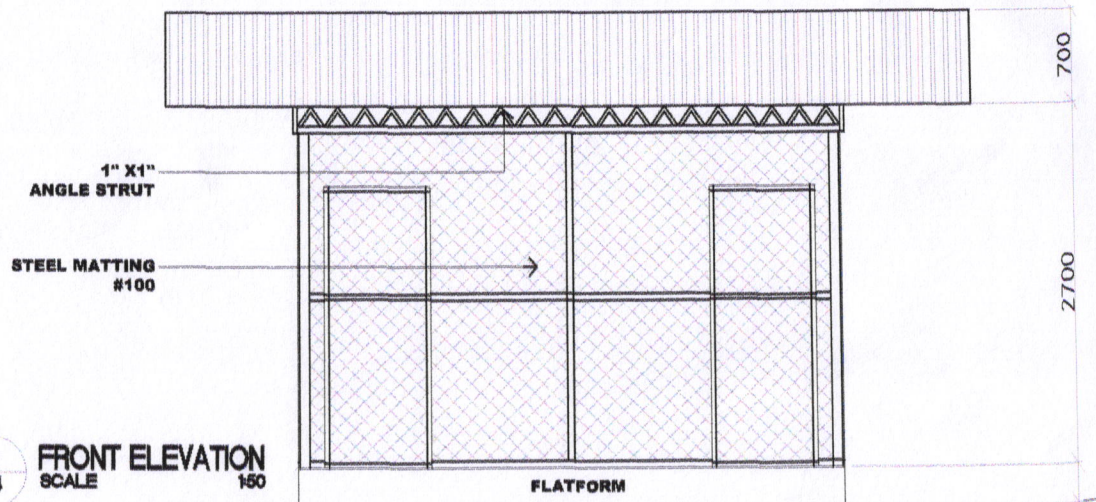

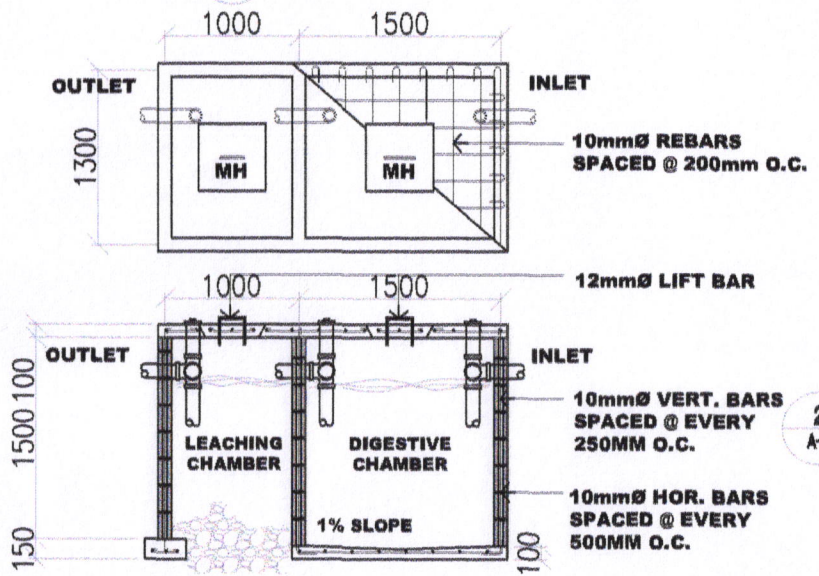

2 FRONT ELEVATION
SCALE 1/50
A-4

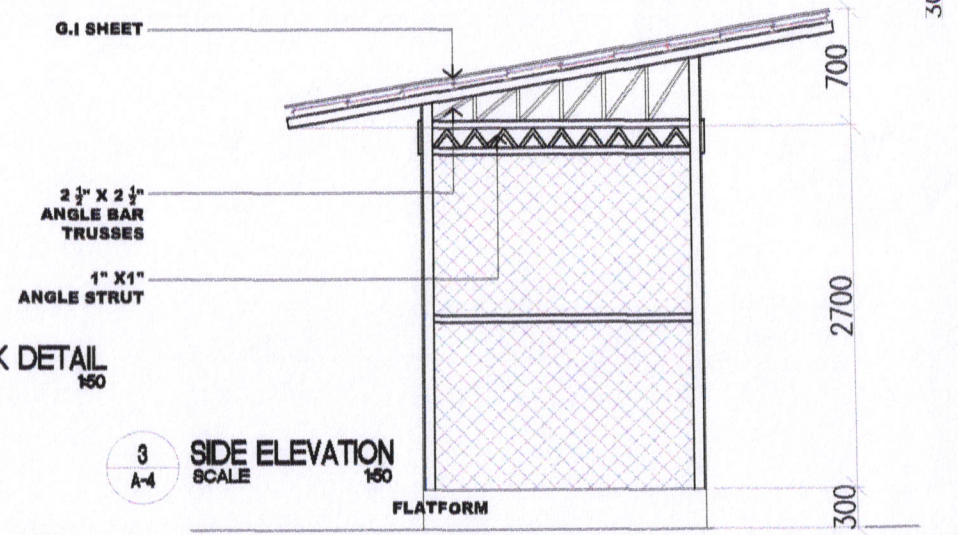

2 SEPTIC TANK DETAIL
SCALE 1/50
A-4

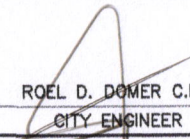
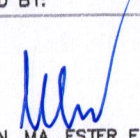

3 SIDE ELEVATION
SCALE 1/50
A-4

PREPARED FROM:	PROJECT TITLE:	DRAWN:	RECOMMENDED BY:	APPROVED BY:	SHEET NO.
 SORSOGON CITY CITY ENGINEER'S OFFICE	REPAIR AND IMPROVEMENT OF EMERGENCY OPERATION CENTER LOCATION: BRGY. CABID-AN, SORSOGON CITY, SORSOGON	 maria lora j. mababona, uap ARCHITECT I	 ROEL D. DOMER C.E. CITY ENGINEER	 HON. MA. ESTER E. HAMOR CITY MAYOR	4 A.4