

⊕ PERSPECTIVE

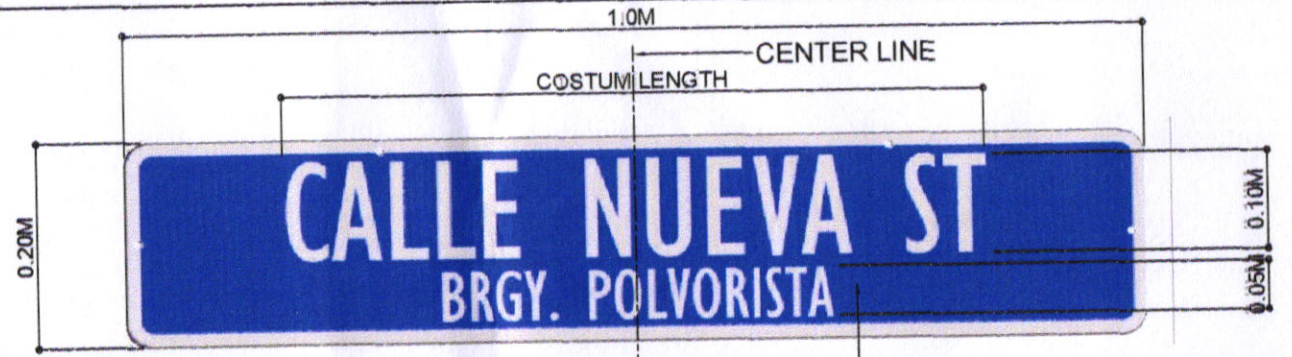

NOTE:

- GILL SANS MT CONDENSED LETTER FONT
- CENTER PRINTED LETTERS
- NAME & DIRECTIONAL PLATES VARRIES VIA LOCATION

3MM THK ALUMINUM PLATE W/ PRINTED LETTERS ON REFLECTORIZED STICKER BOTH SIDES

⊕ SAMPLE STREET NAME PLATE
SIDE A & B



⊕ SAMPLE DIRECTIONAL PLATE
SIDE A & B

 <p>SORSOGON CITY CITY ENGINEER'S OFFICE</p>	PROJECT TITLE:	DRAWN BY:	RECOMMENDING/APPROVAL:	APPROVED BY:
	<p>REPAIR, RESTORATION & INSTALLATION OF STREET SIGNAGES</p> <p>LOCATION: ALONG VARIOUS ROADS ON SORSOGON CITY/PROPER SORSOGON CITY</p>	<p>ROY M. HUBILLA ENGINEERING AIDE</p>	<p>ROEL D. DOMER, CE/RMP OIC - CITY ENGINEER</p>	<p>HON. MA. ESTER E. HAMOR CITY/MAYOR</p>

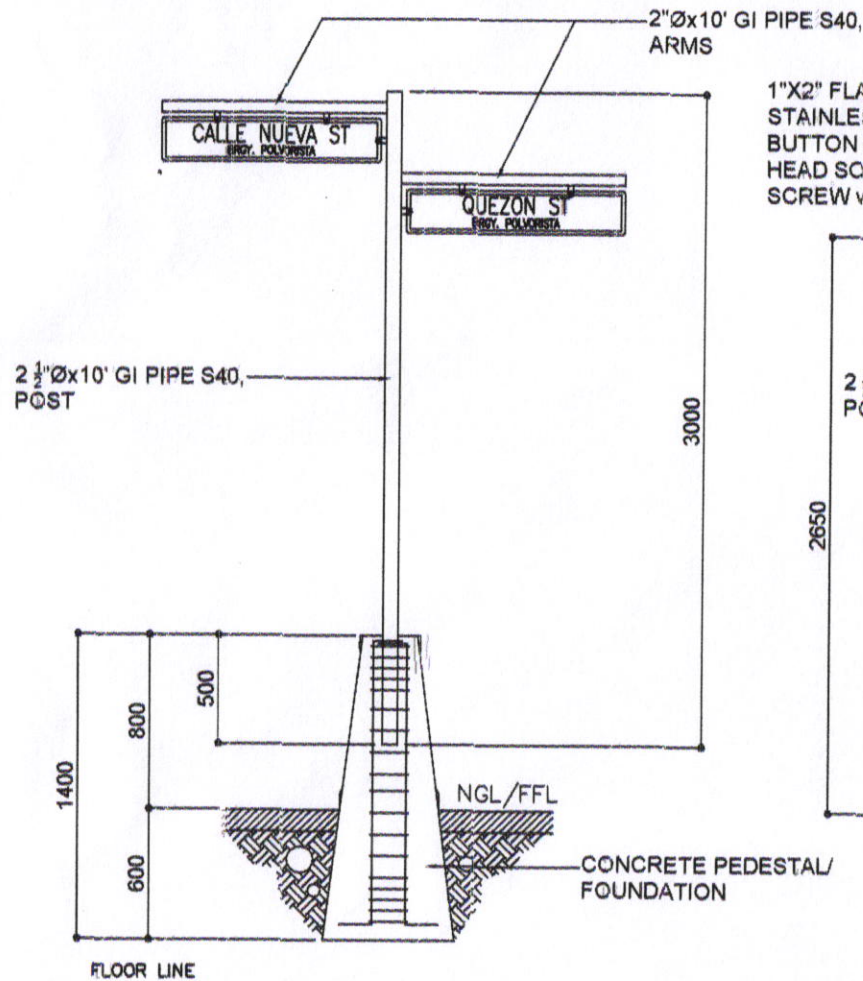

1"X2" FLAT BAR w/
STAINLESS STEEL,
BUTTON HEAD,
HEAD SOCKET CAP
SCREW w/ NUT

2 1/2"Øx10' GI PIPE S40,
POST

500

2 1/2"Øx10' GI PIPE S40,
POST

CONCRETE
PEDESTAL

NGL/FFL

NOTE: REMOVE H-SIGN
4

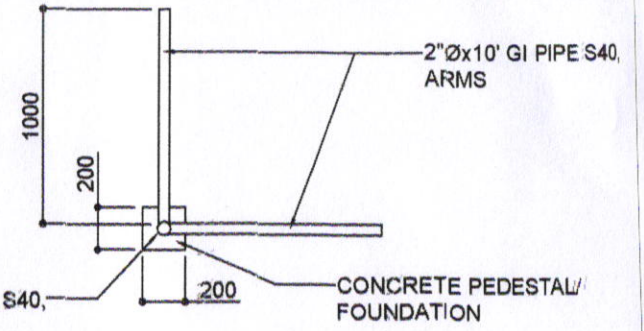

TOP VIEW

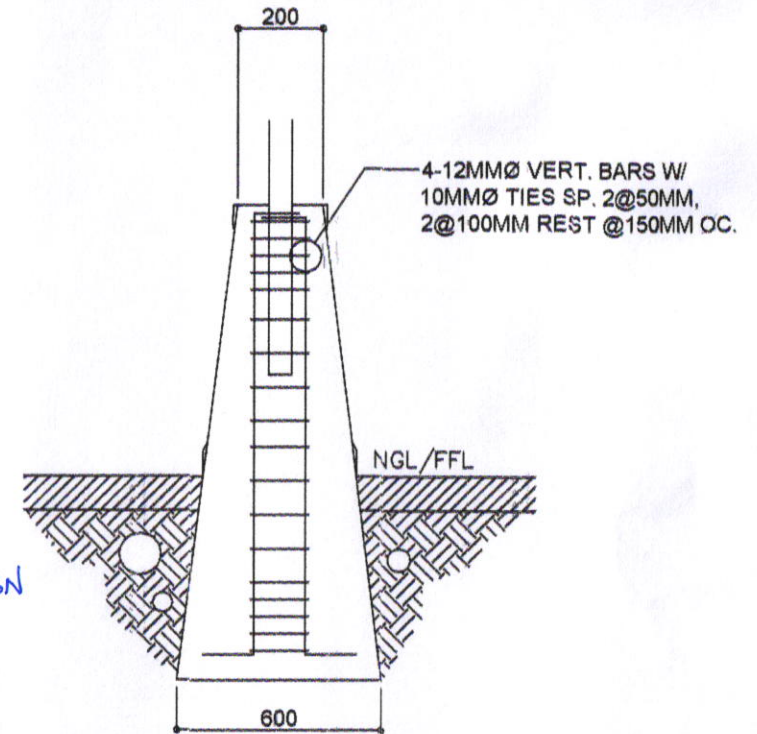

FOUNDATION DET.

ELEVATION DET.
80 UNITS





PROJECT TITLE:	DRAWN BY:	RECOMMENDING APPROVAL:	APPROVED BY:
REPAIR, RESTORATION &/ INSTALLATION OF STREET SIGNAGES			
LOCATION: ALONG VARIOUS ROADS ON SORSOGON CITY PROPER	ROY M. HUBILLA	ROEL D. DOMER, CE/RMP	HON. MA. ESTER E. HAMOR
SORSOGON CITY	ENGINEERING AIDE	CITY ENGINEER	CITY MAYOR

SPOT MAP A

LEGEND:

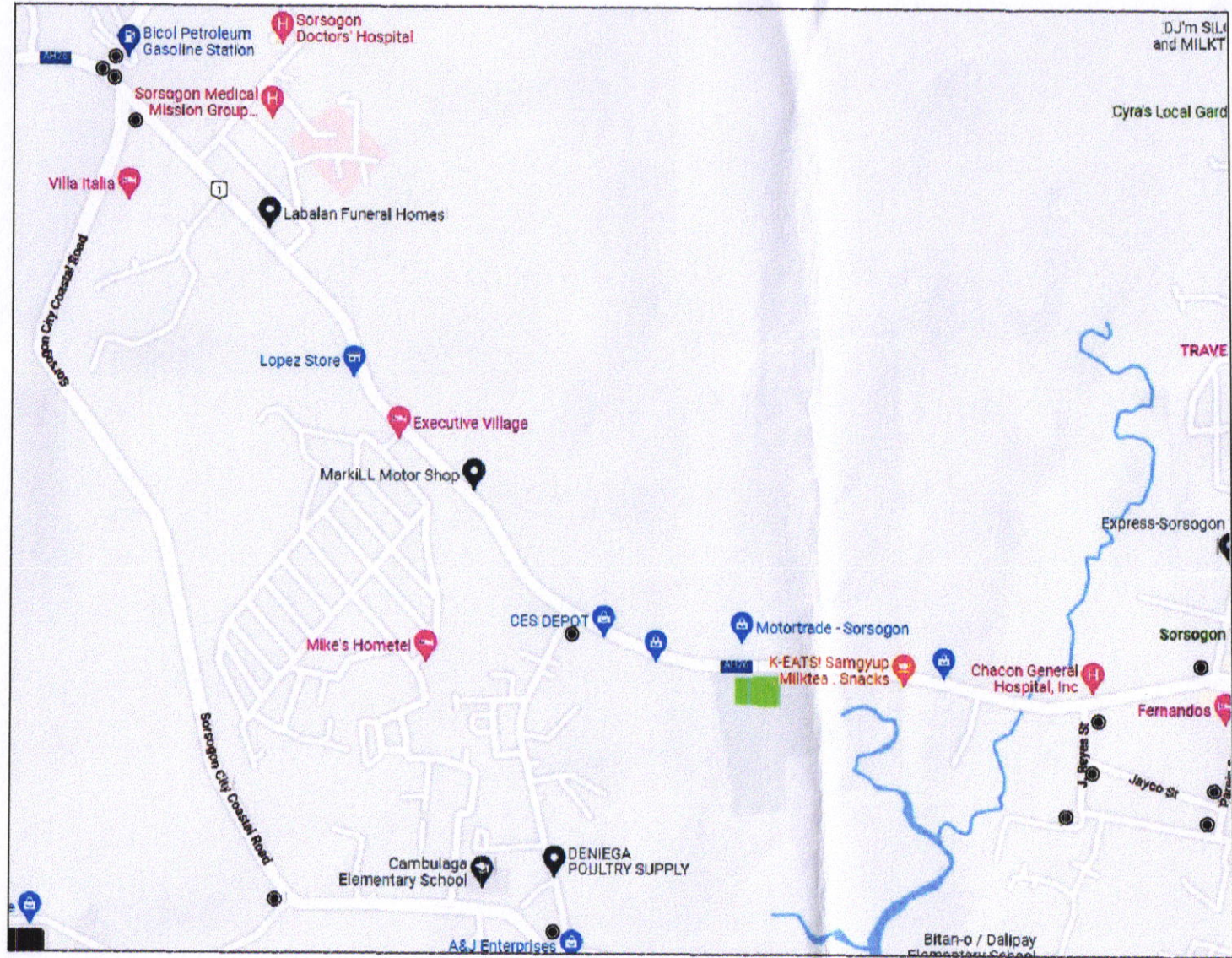
● SIGN POST



<p>SORSOGON CITY</p>  <p>CITY ENGINEER'S OFFICE</p>	PROJECT TITLE:	DRAWN BY:	RECOMMENDING APPROVAL:	APPROVED BY:
	REPAIR, RESTORATION & INSTALLATION OF STREET SIGNAGES			
	LOCATION: ALONG VARIOUS ROADS ON SORSOGON CITY (PROPER SORSOGON CITY)	ROY M. HUBILLA ENGINEERING AIDE	ROEL D. DOMER, CE/RMP CIC - CITY ENGINEER	HON. MA. ESTER E. HAMOR CITY MAYOR

SPOT MAP B

LEGEND:

● SIGN POST



<p>SORSOGON CITY</p>  <p>CITY ENGINEER'S OFFICE</p>	PROJECT TITLE:	DRAWN BY:	RECOMMENDING APPROVAL:	APPROVED BY:
	REPAIR, RESTORATION &/ INSTALLATION OF STREET SIGNAGES			
	LOCATION: ALONG VARIOUS ROADS ON SORSOGON CITY PROPER SORSOGON CITY	ROY M. HUBILLA ENGINEERING AIDE	ROEL D. DOMER, CE/RMP OIC - CITY ENGINEER	HON. MA. ESTER E. HAMOR CITY MAYOR



SPOT MAP C

LEGEND:

● SIGN POST

SORSOGON CITY



CITY ENGINEER'S
OFFICE

PROJECT TITLE:

REPAIR, RESTORATION & INSTALLATION
OF STREET SIGNAGES

LOCATION: ALONG VARIOUS ROADS ON SORSOGON CITY PROPER
SORSOGON CITY

DRAWN BY:

ROY M. HUBILLA
ENGINEERING AIDE

RECOMMENDING APPROVAL:

ROEL D. DOMER, CE/RMP
OIC - CITY ENGINEER

APPROVED BY:

HON. MA. ESTER E. HAMOR
CITY MAYOR

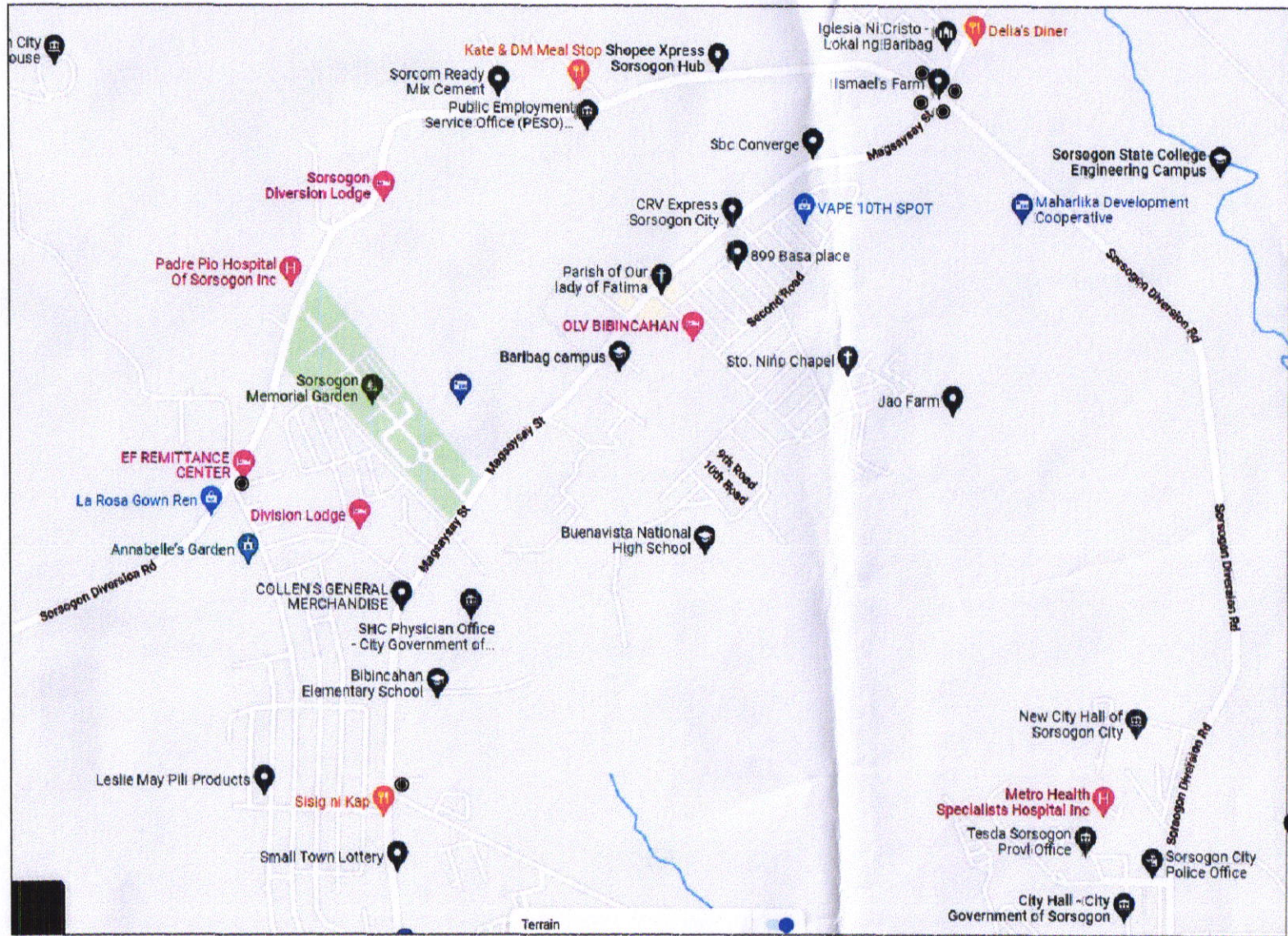

SPOT MAP D

LEGEND:

● SIGN POST

<p>SORSOGON CITY</p>  <p>CITY ENGINEER'S OFFICE</p>	PROJECT TITLE:	DRAWN BY:	RECOMMENDING APPROVAL:	APPROVED BY:
	REPAIR, RESTORATION & INSTALLATION OF STREET SIGNAGES			
	LOCATION: ALONG VARIOUS ROADS ON SORSOGON CITY PROPER SORSOGON CITY	ROY M. HUBILLA ENGINEERING AIDE	ROEL D. DOMER, CE/RMP OIC - CITY ENGINEER	HON. MA. ESTER E. HAMOR CITY MAYOR