

PREPARED FROM:	PROJECT TITLE:	CADD:	RECOMMENDED BY:	APPROVED BY:
 SORSOGON CITY CITY ENGINEER'S OFFICE	CONSTRUCTION/ REPAIR / IMPROVEMENT OF DAYCARE LOCATION: BRGY. BUENAVISTA, BACON DISTRICT, SORSOGON CITY	ROWANFMARBELLA DRAFTSMAN III	 ROEL D. DIMER C.E. / RMP OIC-CITY ENGINEER	HON. MA. ESTER E. HAMOR CITY MAYOR

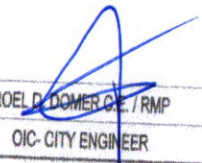

ROOF PLAN
SCALE : 1:100M.

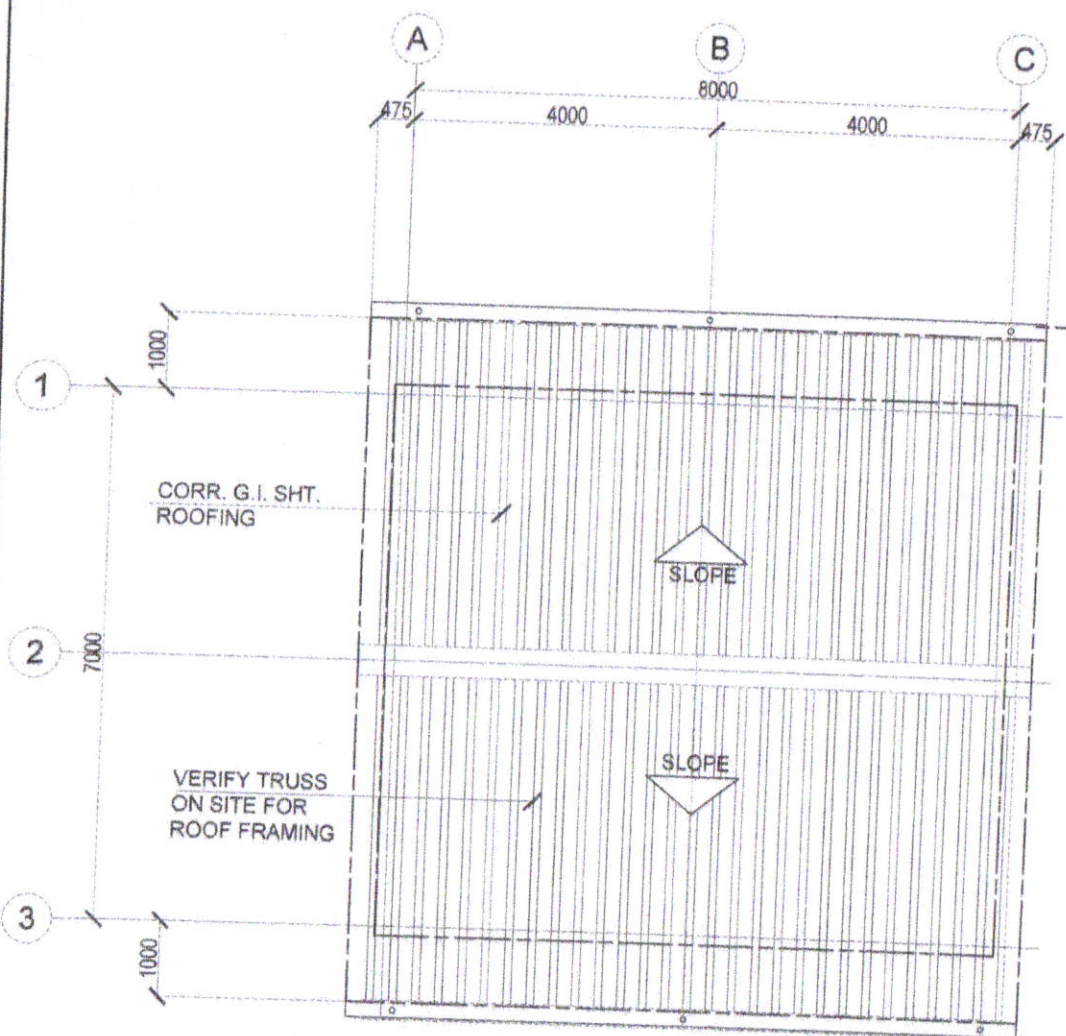
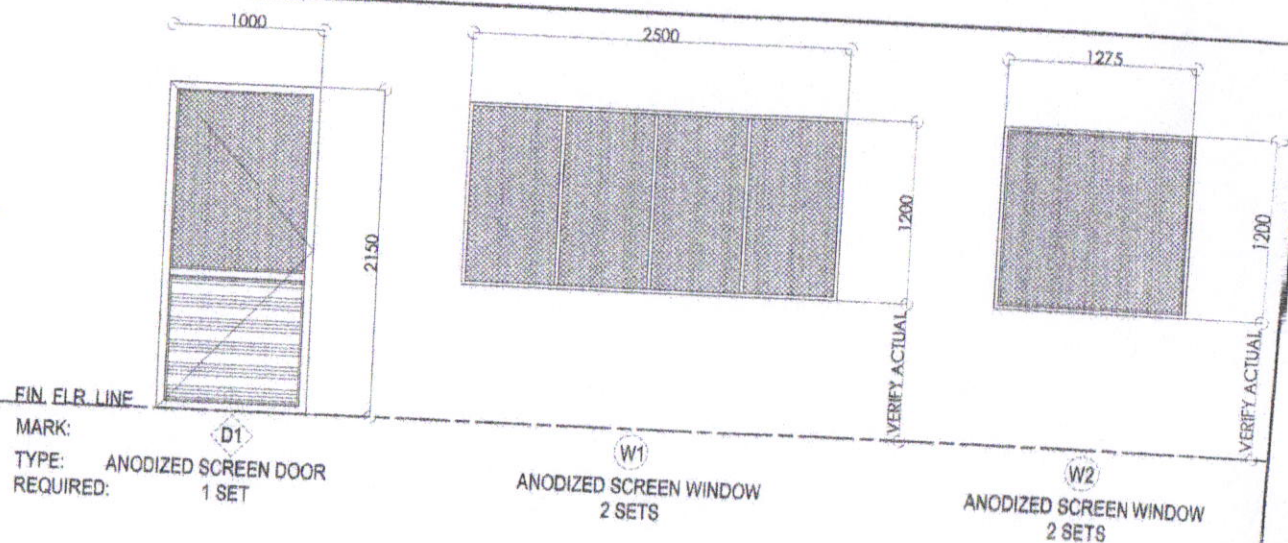

MARK: D1, W1, W2
 TYPE: ANODIZED SCREEN DOOR, ANODIZED SCREEN WINDOW
 REQUIRED: 1 SET, 2 SETS, 2 SETS

SCHEDULE OF SCREEN WINDOWS & DOORS
SCALE : 1:40M.

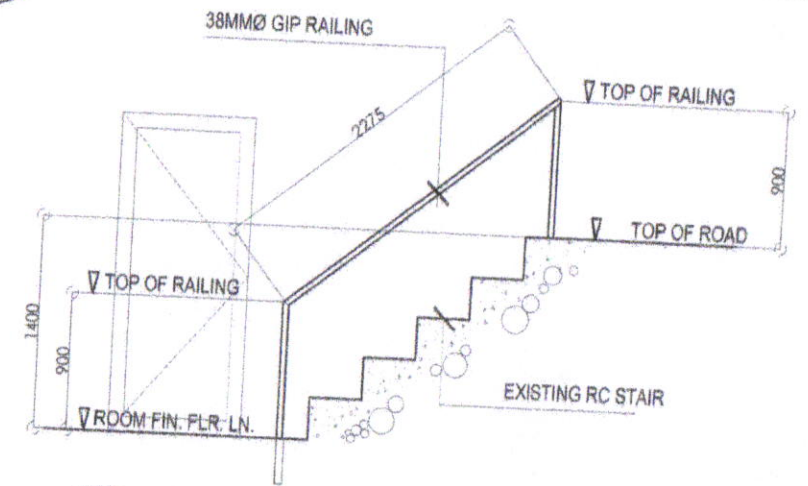

DETAIL OF RAILINGS
SCALE : 1:40M.

PREPARED FROM:	PROJECT TITLE:	CADD:	RECOMMENDED BY:	APPROVED BY:
<p>SORSOGON CITY CITY ENGINEER'S OFFICE</p>	CONSTRUCTION/ REPAIR / IMPROVEMENT OF DAYCARE			
	LOCATION: BRGY. BUENAVISTA, BACON DISTRICT, SORSOGON CITY	ROWANFMARBELLA DRAFTSMAN III	ROELDO DOMER C.E. / RMP OIC- CITY ENGINEER	HON. MA. ESTER E. HAMOR CITY MAYOR

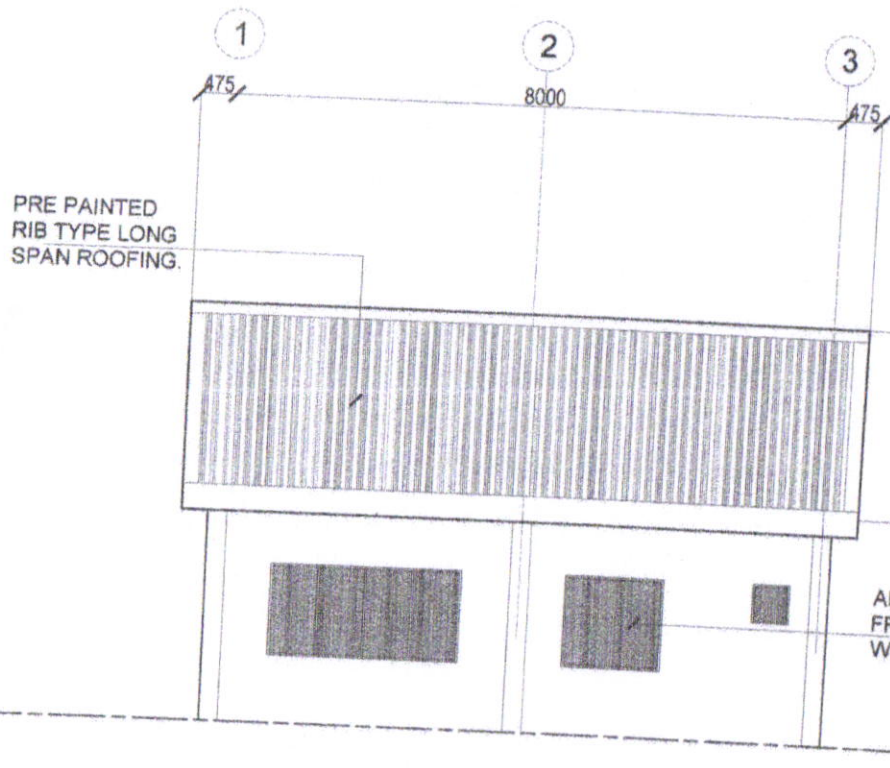

LEFT SIDE ELEVATION
SCALE : 1:100M.

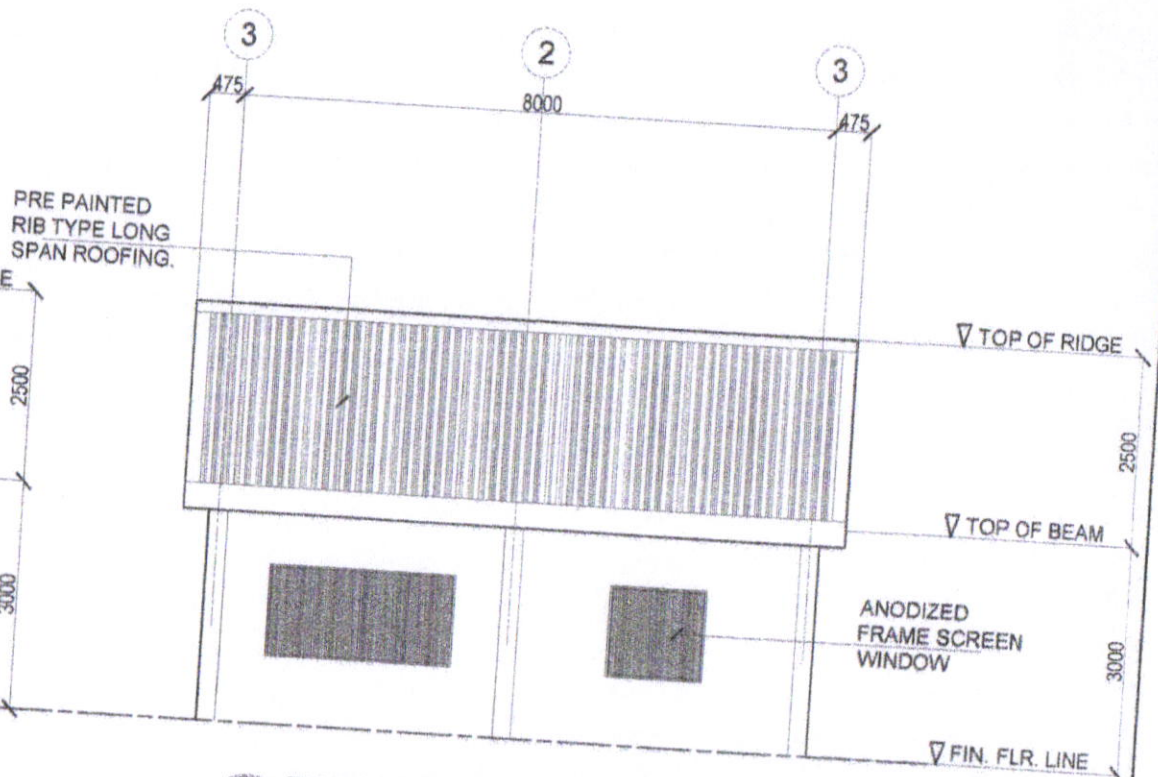

RIGHT SIDE ELEVATION
SCALE : 1:100M.

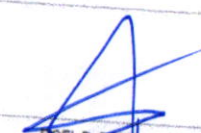
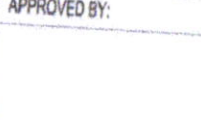
<p>PREPARED FROM:</p> <p>CITY ENGINEER'S OFFICE</p>  <p>SORSOGON CITY CITY ENGINEER'S OFFICE</p>	<p>PROJECT TITLE:</p> <p>CONSTRUCTION/ REPAIR / IMPROVEMENT OF DAYCARE</p> <p>LOCATION: BRGY. BUENAVISTA, BACON DISTRICT, SORSOGON CITY</p>	<p>CADD:</p> <p>ROWANFIMARBELLA DRAFTSMAN III</p>	<p>RECOMMENDED BY:</p> <p> ROWANFIMARBELLA OIC- CITY ENGINEER</p>	<p>APPROVED BY:</p> <p> HON. MA. ESTER E. HAMOR CITY MAYOR</p>
---	--	---	--	---

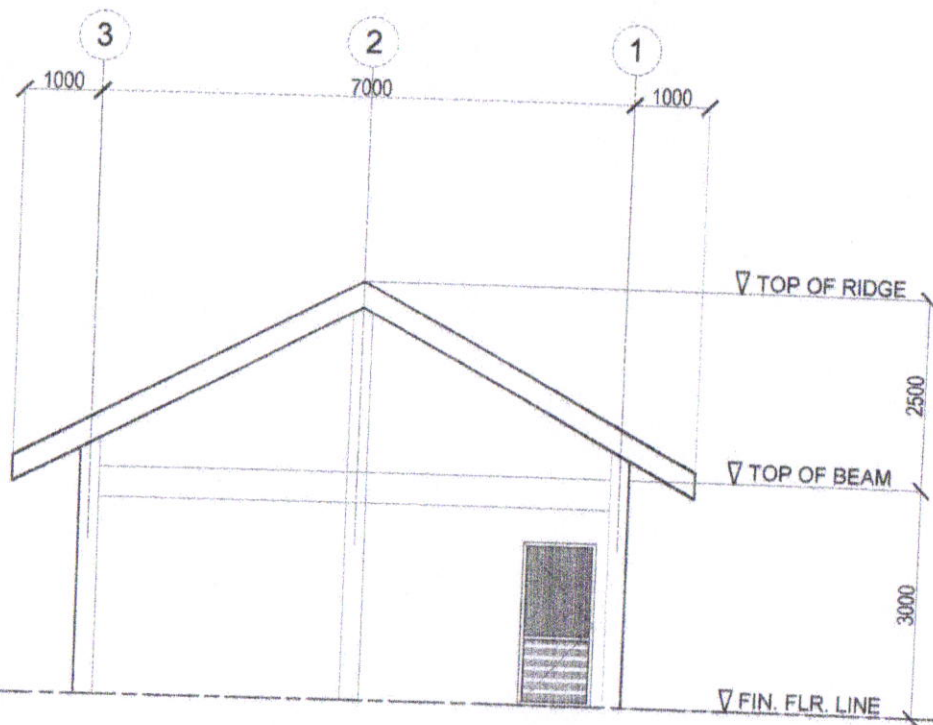

FRONT ELEVATION
SCALE : 1:100M.

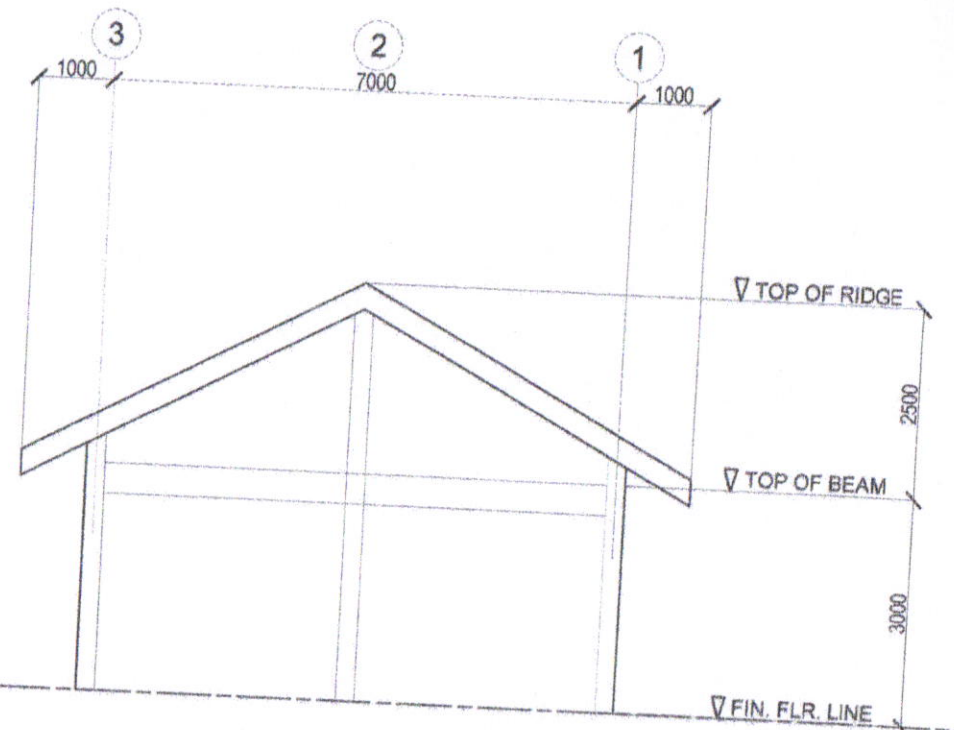

REAR ELEVATION
SCALE : 1:100M.

PREPARED FROM:	PROJECT TITLE:	CADD:	RECOMMENDED BY:	APPROVED BY:
 <p>SORSOGON CITY CITY ENGINEER'S OFFICE</p>	<p>CONSTRUCTION/ REPAIR / IMPROVEMENT OF DAYCARE</p> <p>LOCATION: BRGY. BUENAVISTA, BACON DISTRICT, SORSOGON CITY</p>	<p>ROWANF MARBELLA DRAFTSMAN III</p>	<p>ROEL P. DOMER, C.E., R.M.P. CITY ENGINEER</p>	<p>HON. MA. ESTER E. HAMOR CITY MAYOR</p>

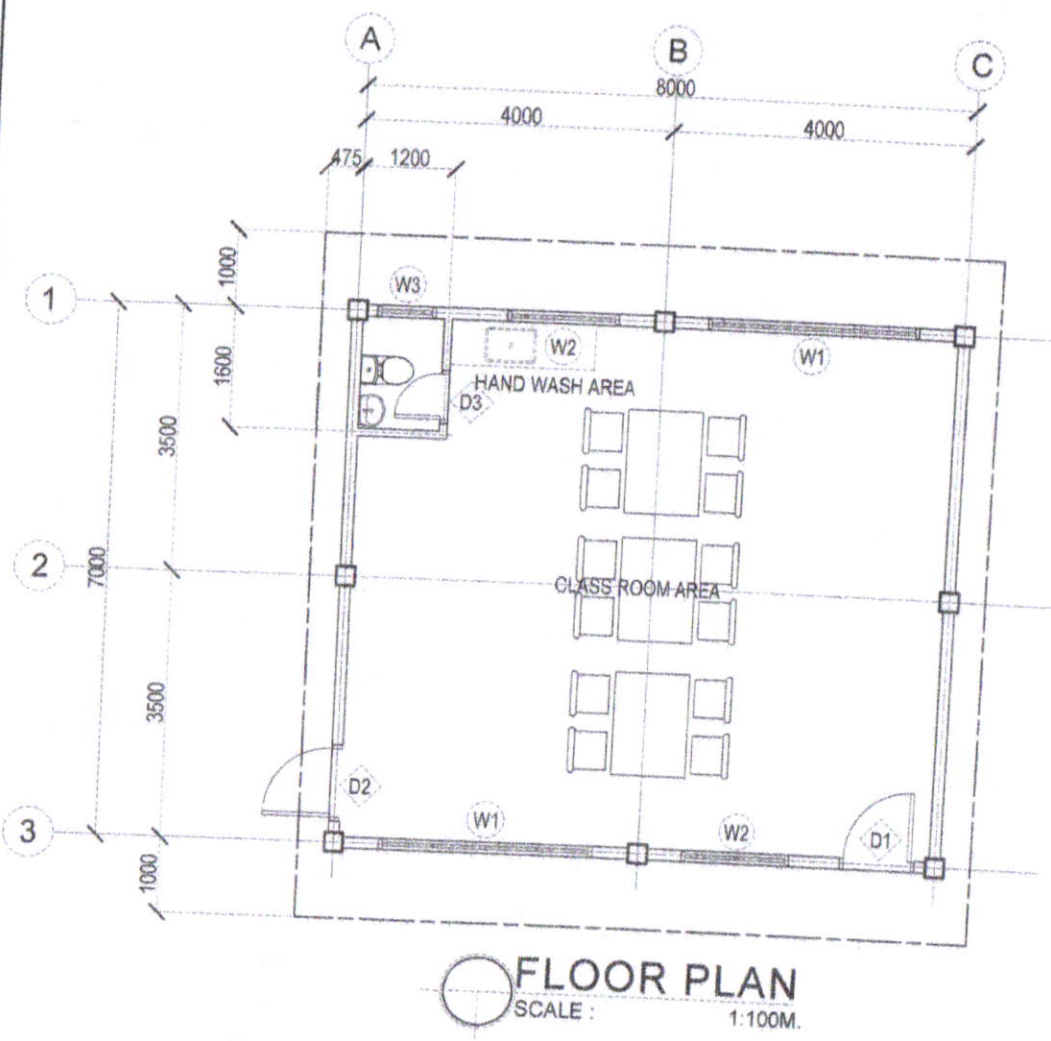

FLOOR PLAN
SCALE : 1:100M.

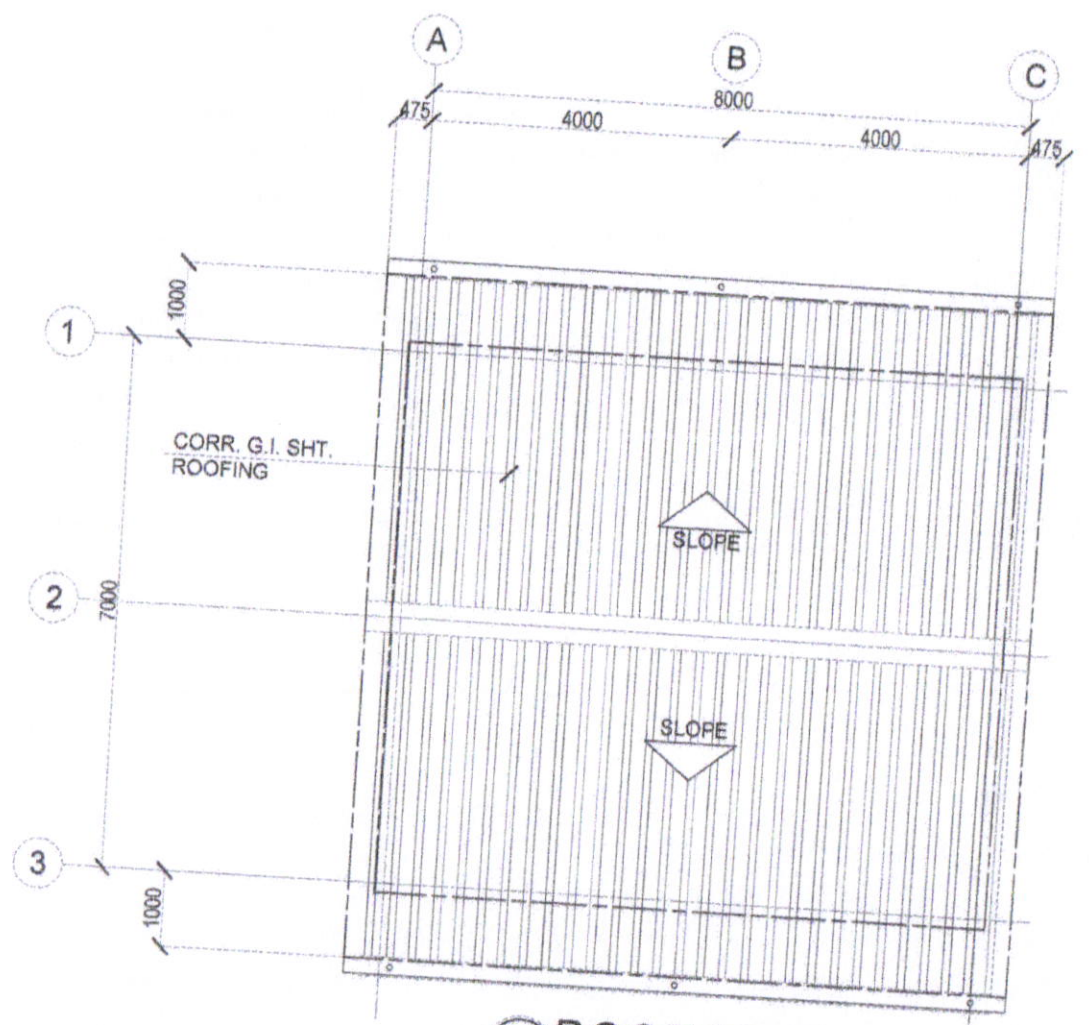

ROOF PLAN
SCALE : 1:100M.

PREPARED FROM: CITY ENGINEER'S OFFICE	PROJECT TITLE: CONSTRUCTION/ REPAIR / IMPROVEMENT OF DAYCARE	CADD: ROWANFARBELLA DRAFTSMAN III	RECOMMENDED BY: ROEL D. DOMESTICO / RMP C/C - CITY ENGINEER	APPROVED BY: HON. MA. ESTER E. HAMOR CITY MAYOR
 <p>SORSOGON CITY CITY ENGINEER'S OFFICE</p>	LOCATION: BRGY. SAWANGA, BACON DISTRICT, SORSOGON CITY			

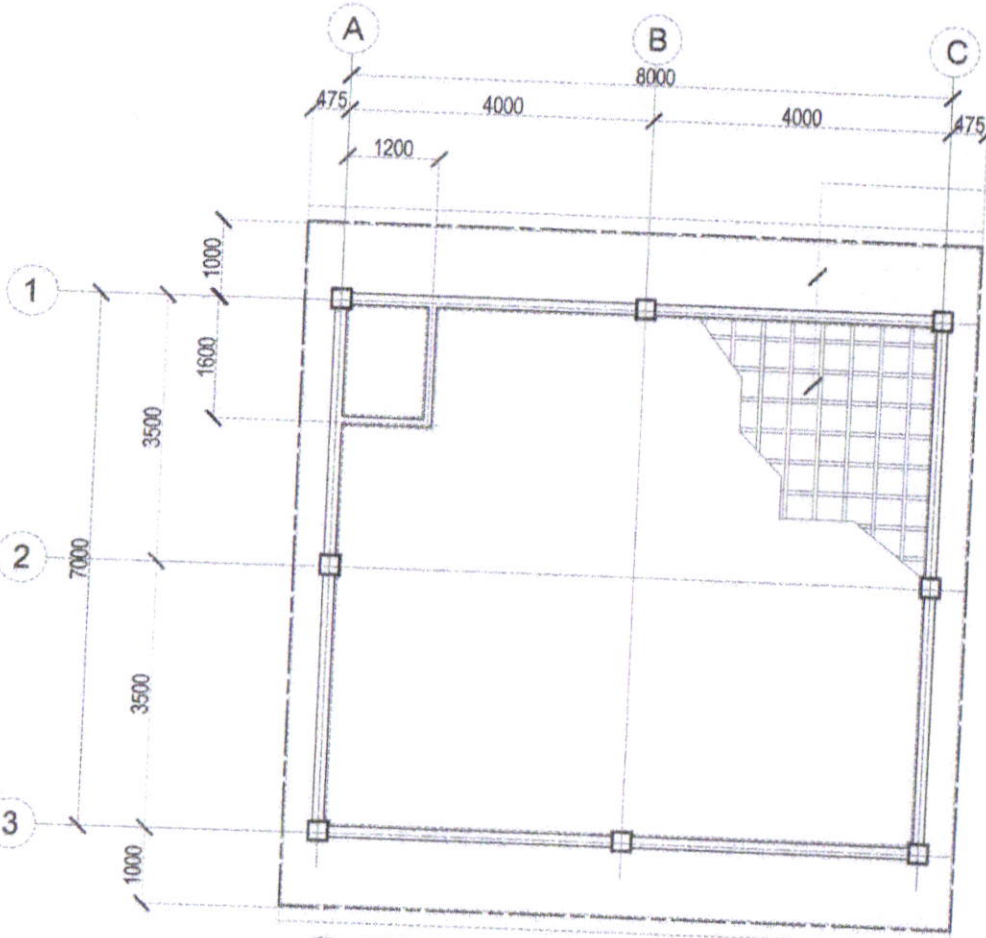

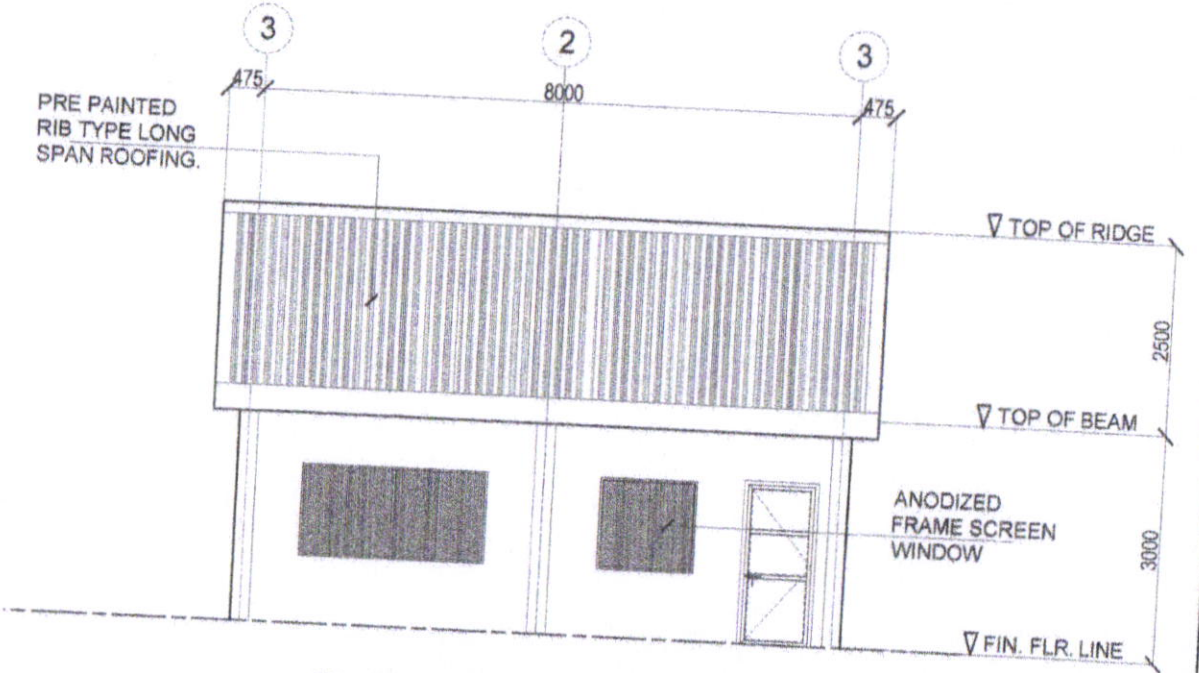

4.6MM THK FICEM BOARD ON METAL FURRING CEILING JOIST SPACED @ 400MM ON CENTER BOTHWAYS.

REFLECTED CEILING PLAN
SCALE: 1:100M.



FRONT ELEVATION
SCALE: 1:100M.

<p>PREPARED FROM:</p>  <p>SORSOGON CITY CITY ENGINEER'S OFFICE</p>	<p>PROJECT TITLE: CONSTRUCTION/ REPAIR / IMPROVEMENT OF DAYCARE</p> <p>LOCATION: BRGY. SAWANGA, BACON DISTRICT, SORSOGON CITY</p>	<p>CADD: ROWANFMARBELLA DRAFTSMAN III</p>	<p>RECOMMENDED BY:  ROWAN D. DOMER C.E. / RMP OIC-CITY ENGINEER</p>	<p>APPROVED BY: HON. MA. ESTER E. HAMOR CITY MAYOR</p>
--	--	---	--	---

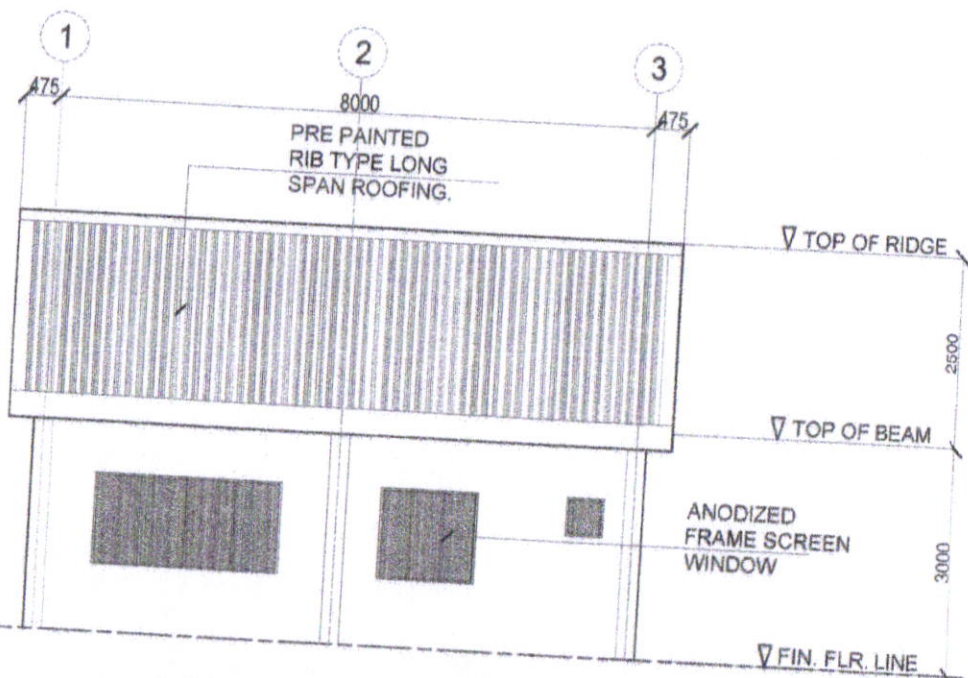
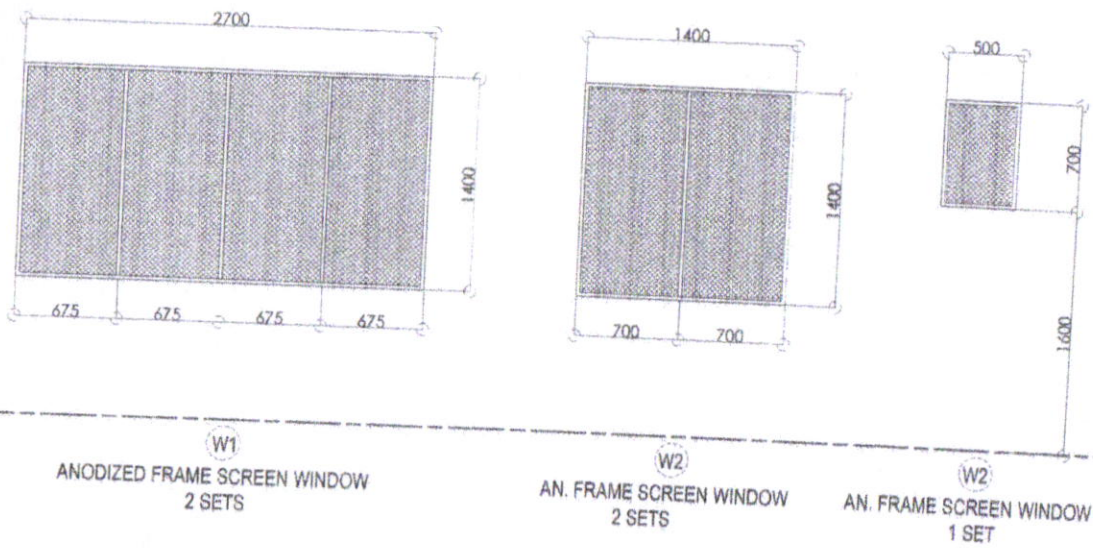
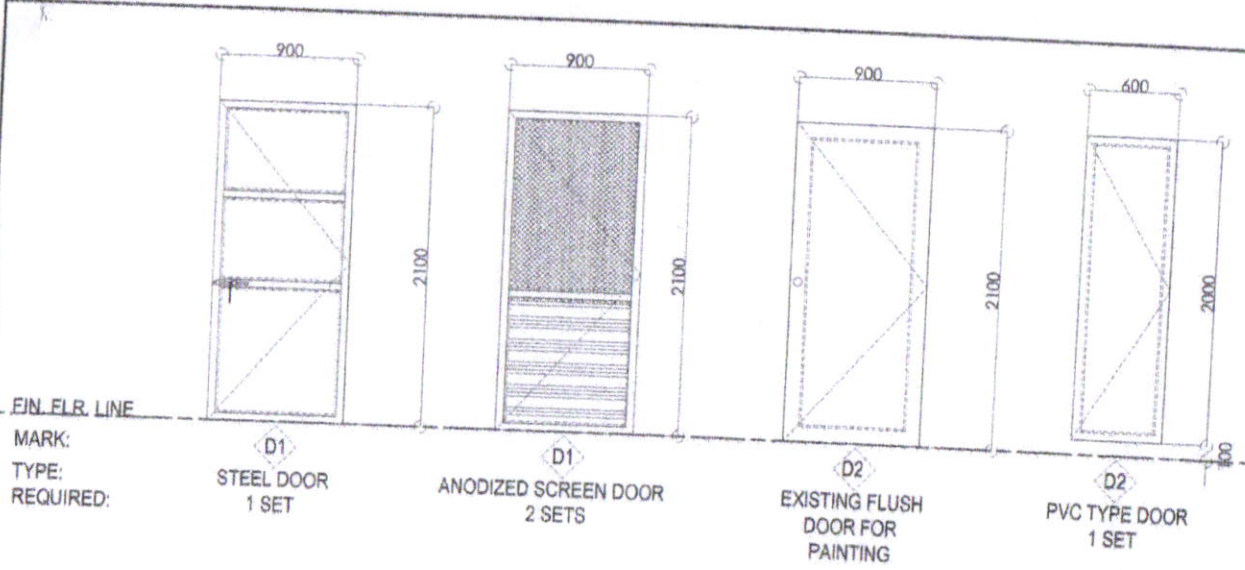

REAR ELEVATION
SCALE: 1:100M.

SCHEDULE OF SCREEN WINDOWS & DOORS
SCALE: 1:50M.

PREPARED FROM:	PROJECT TITLE:	CADD:	RECOMMENDED BY:	APPROVED BY:
<p>SORSOGON CITY CITY ENGINEER'S OFFICE</p>	<p>CONSTRUCTION/ REPAIR / IMPROVEMENT OF DAYCARE</p> <p>LOCATION: BRGY. SAWANGA, BACON DISTRICT, SORSOGON CITY</p>	<p>ROWANFMARBELLA DRAFTSMAN III</p>	<p> ROID D. DOMERCQ / RMP OIC- CITY ENGINEER</p>	<p>HON. MA. ESTER E. HAMOR CITY MAYOR</p>

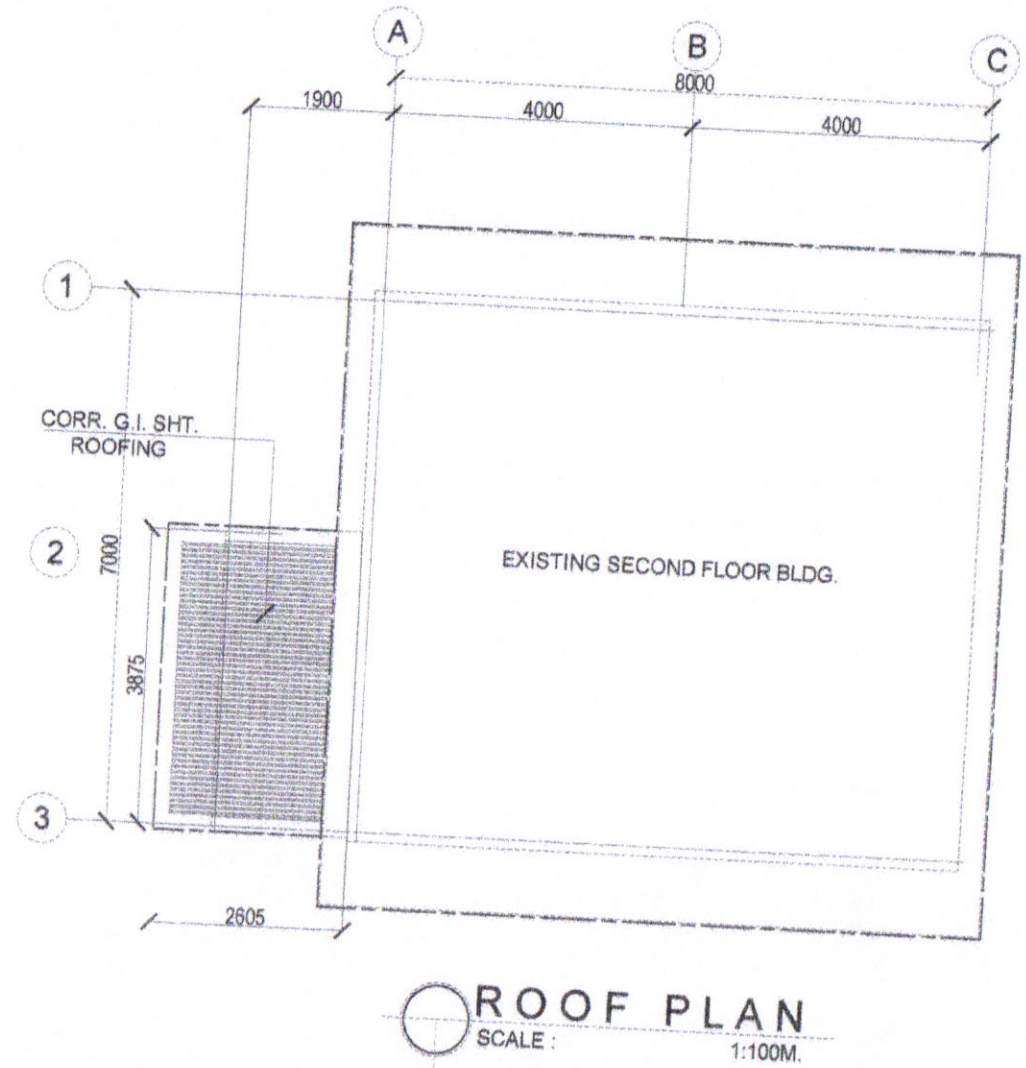
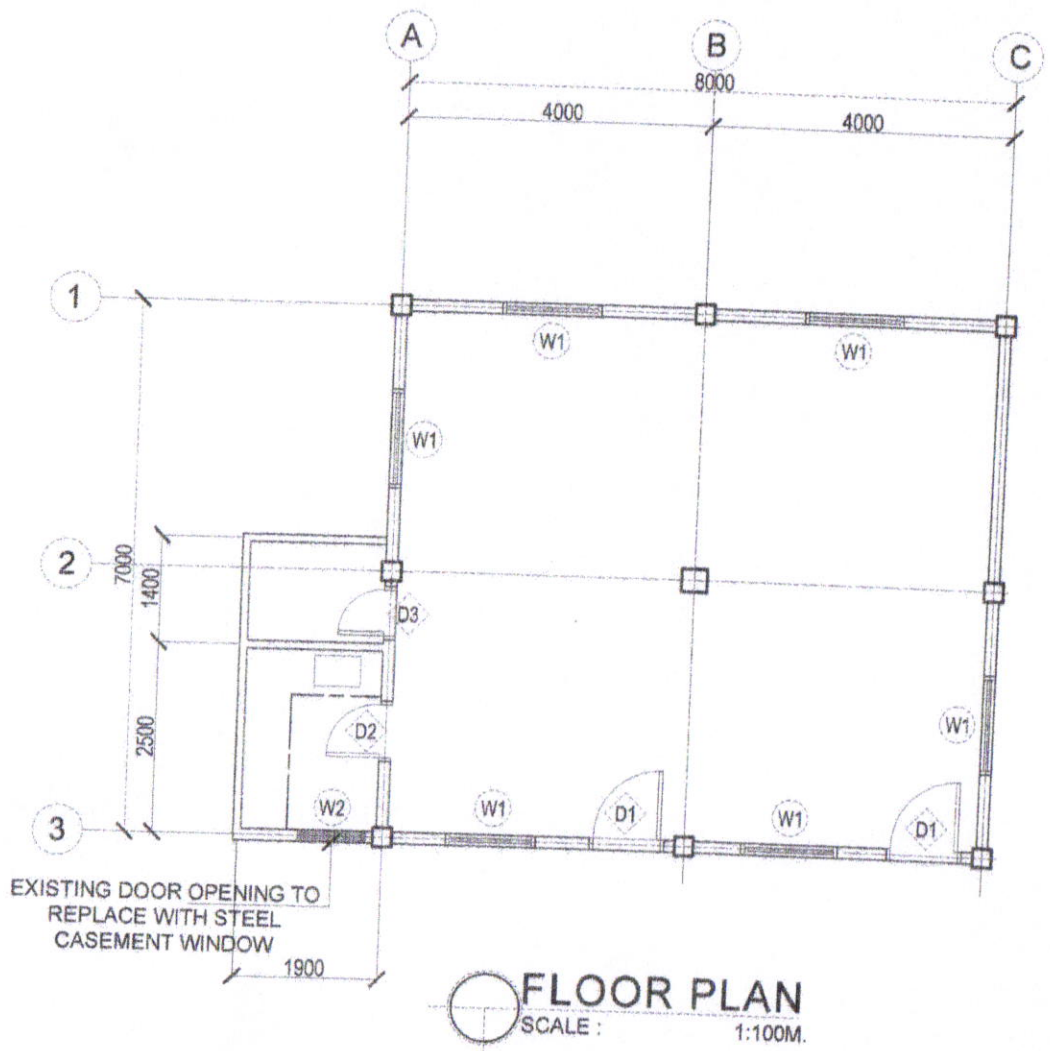

PREPARED FROM:	PROJECT TITLE:	CADD:	RECOMMENDED BY:	APPROVED BY:
 <p>SORSOGON CITY CITY ENGINEER'S OFFICE</p>	CONSTRUCTION/ REPAIR / IMPROVEMENT OF DAYCARE			
	LOCATION: BRGY. GATBO, BACON DISTRICT, SORSOGON CITY	ROWANFARBELLA DRAFTSMAN III	ROEL D. DOMER OIC / RMP OIC-CITY ENGINEER	HON. MA. ESTER E. HAMOR CITY MAYOR

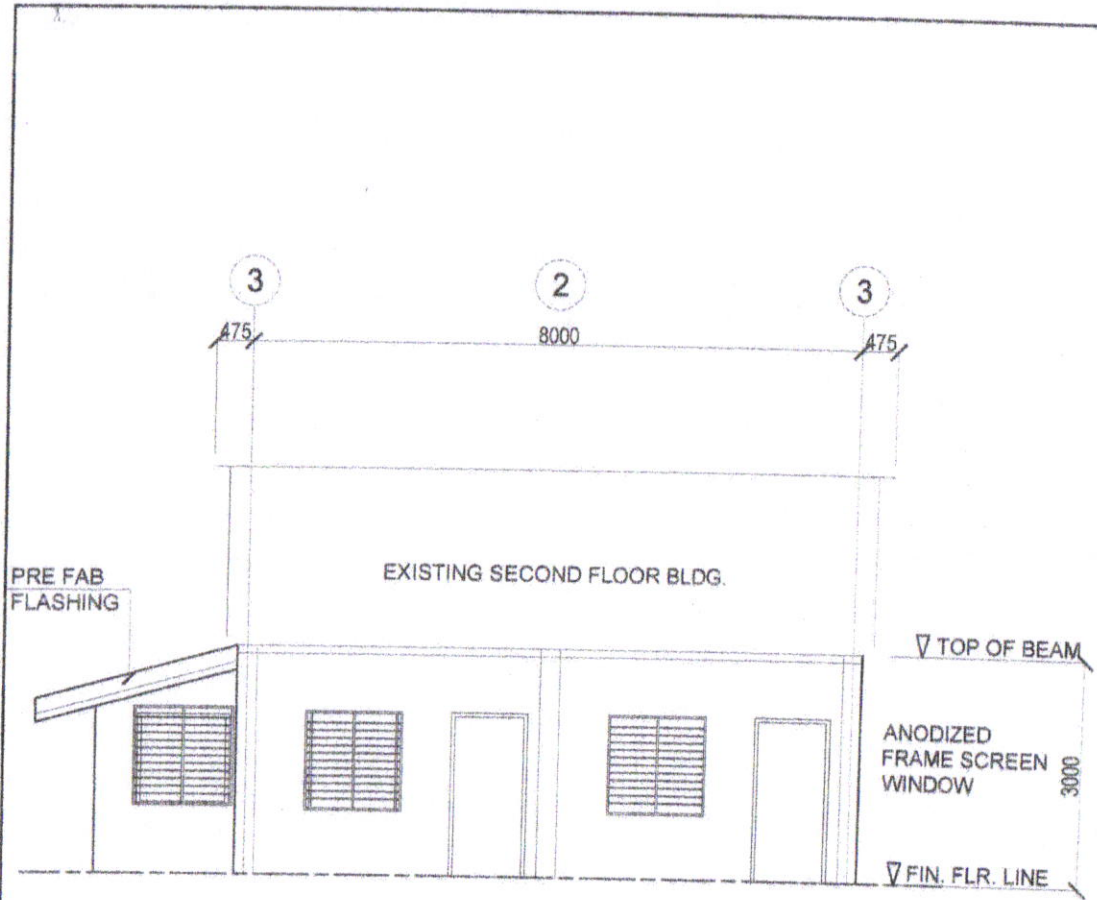

FRONT ELEVATION
SCALE: 1:100M.

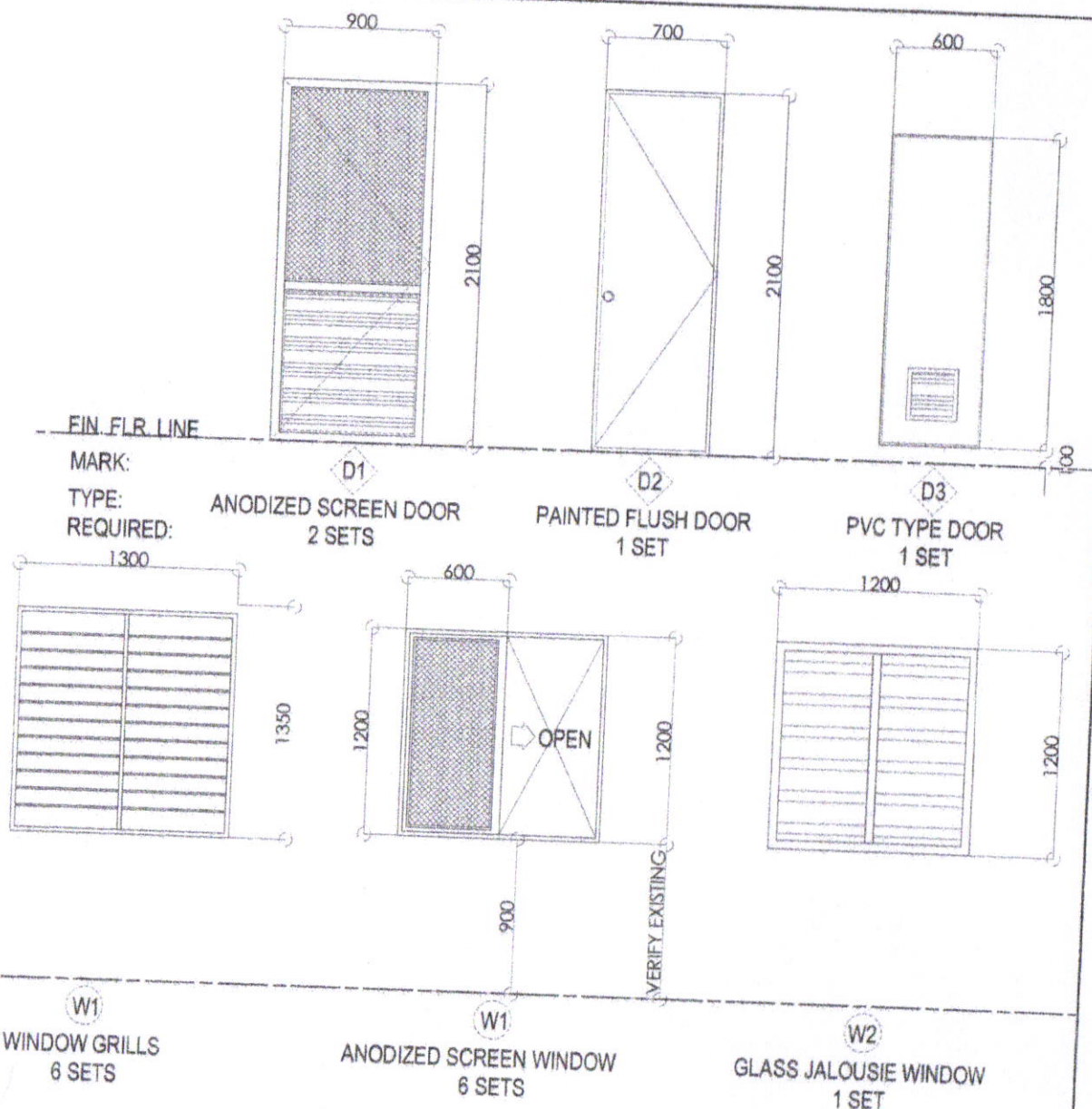

FIN. FLR. LINE

MARK: D1, D2, D3
 TYPE: ANODIZED SCREEN DOOR 2 SETS, PAINTED FLUSH DOOR 1 SET, PVC TYPE DOOR 1 SET
 REQUIRED:

W1 WINDOW GRILLS 6 SETS, W1 ANODIZED SCREEN WINDOW 6 SETS, W2 GLASS JALOUSIE WINDOW 1 SET

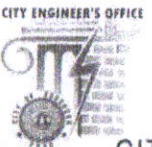
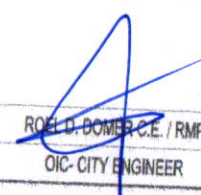
PREPARED FROM:	PROJECT TITLE:	CADD:	RECOMMENDED BY:	APPROVED BY:
 SORSOGON CITY CITY ENGINEER'S OFFICE	CONSTRUCTION/ REPAIR / IMPROVEMENT OF DAYCARE			
	LOCATION: BRGY. GATBO, BACON DISTRICT, SORSOGON CITY	ROWANF MARBELLA DRAFTSMAN III	 ROEL D. BOMER, C.E. / RMP OIC- CITY ENGINEER	HON. MA. ESTER E. HAMOR CITY MAYOR

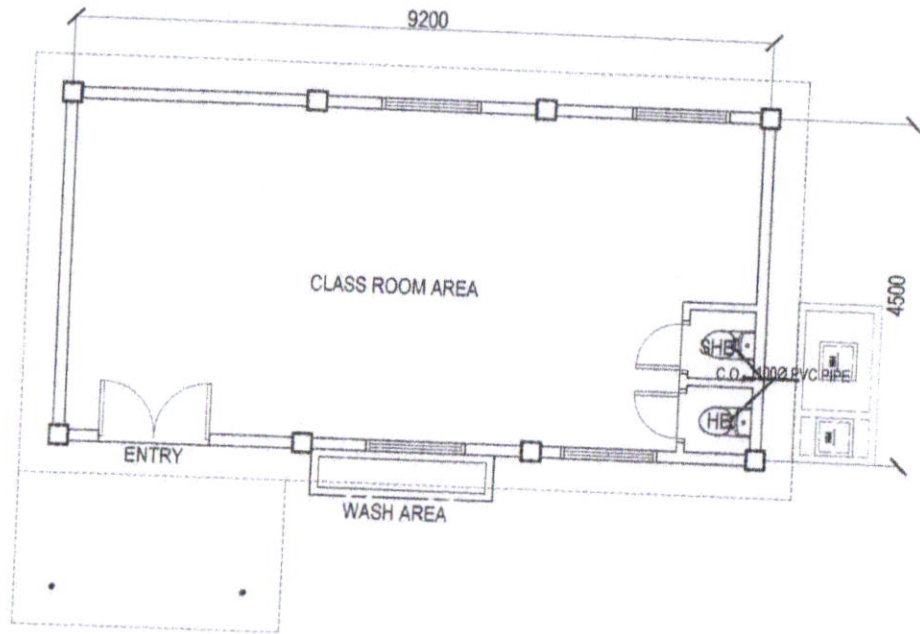

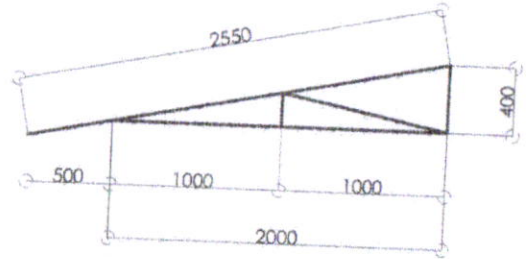

FLOOR PLAN
SCALE : 1:100M.

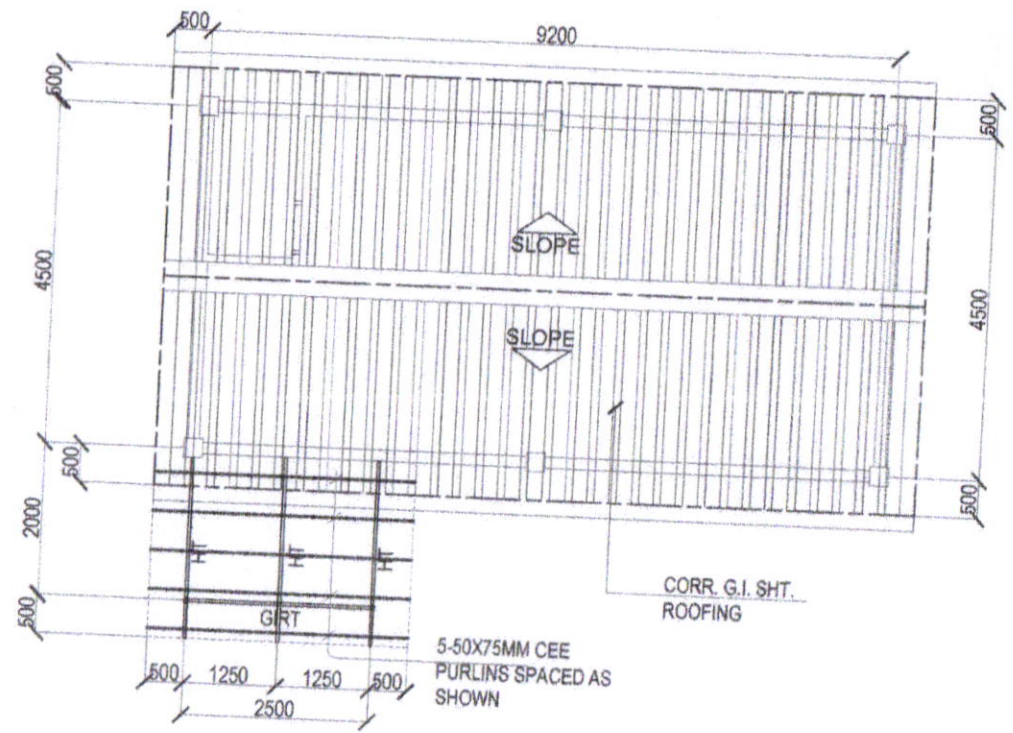

TRUSS DIAGRAM
SCALE : 1:45M.



ROOF PLAN / ROOF FRAMING PLAN
SCALE : 1:100M.

PREPARED FROM:	PROJECT TITLE:	CADD:	RECOMMENDED BY:	APPROVED BY:
 SORSOGON CITY CITY ENGINEER'S OFFICE	CONSTRUCTION/ REPAIR / IMPROVEMENT OF DAYCARE LOCATION: BRGY. SUGOD, BACON DISTRICT, SORSOGON CITY	ROWANF MARBELLA DRAFTSMAN III	 ROEL D. ROMERO OIC- CITY ENGINEER	HON. MA. ESTER E. HAMOR CITY MAYOR

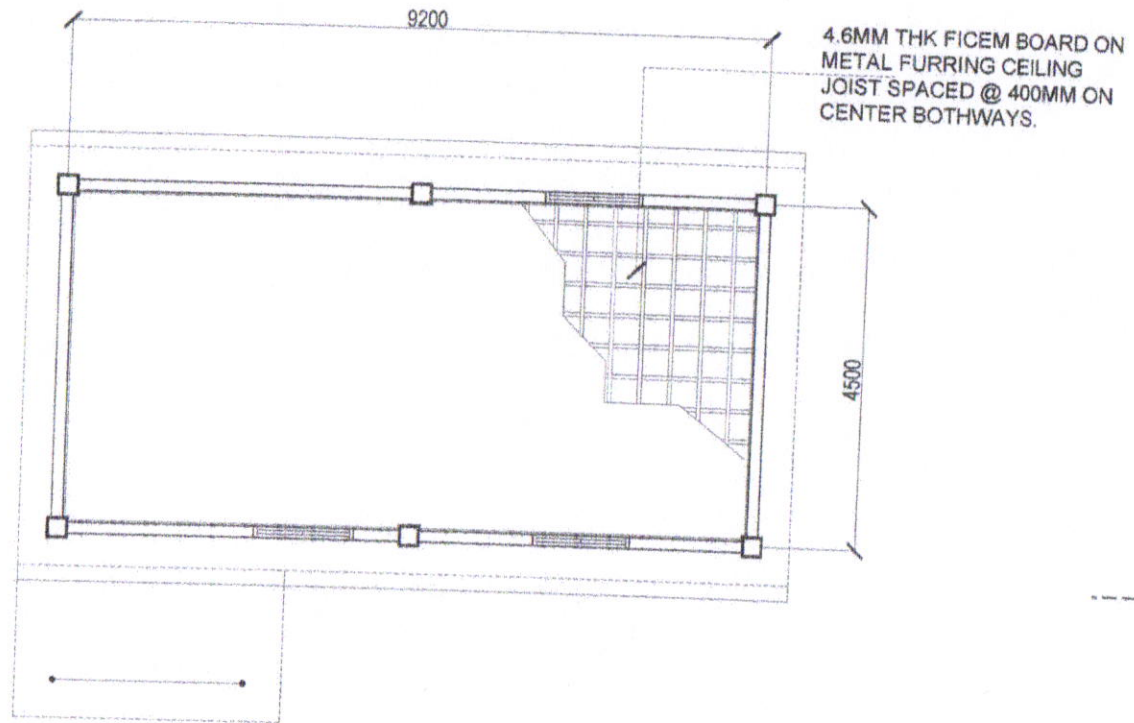

REFLECTED CEILING PLAN
SCALE : 1:100M.

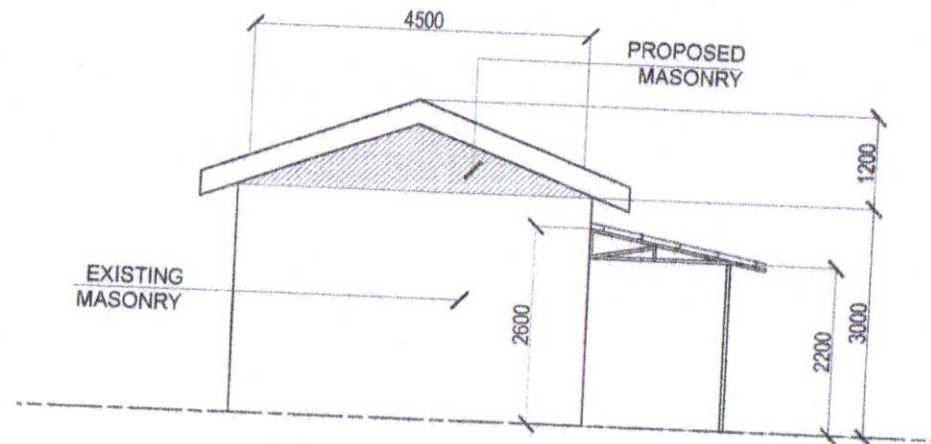

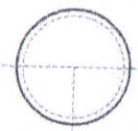
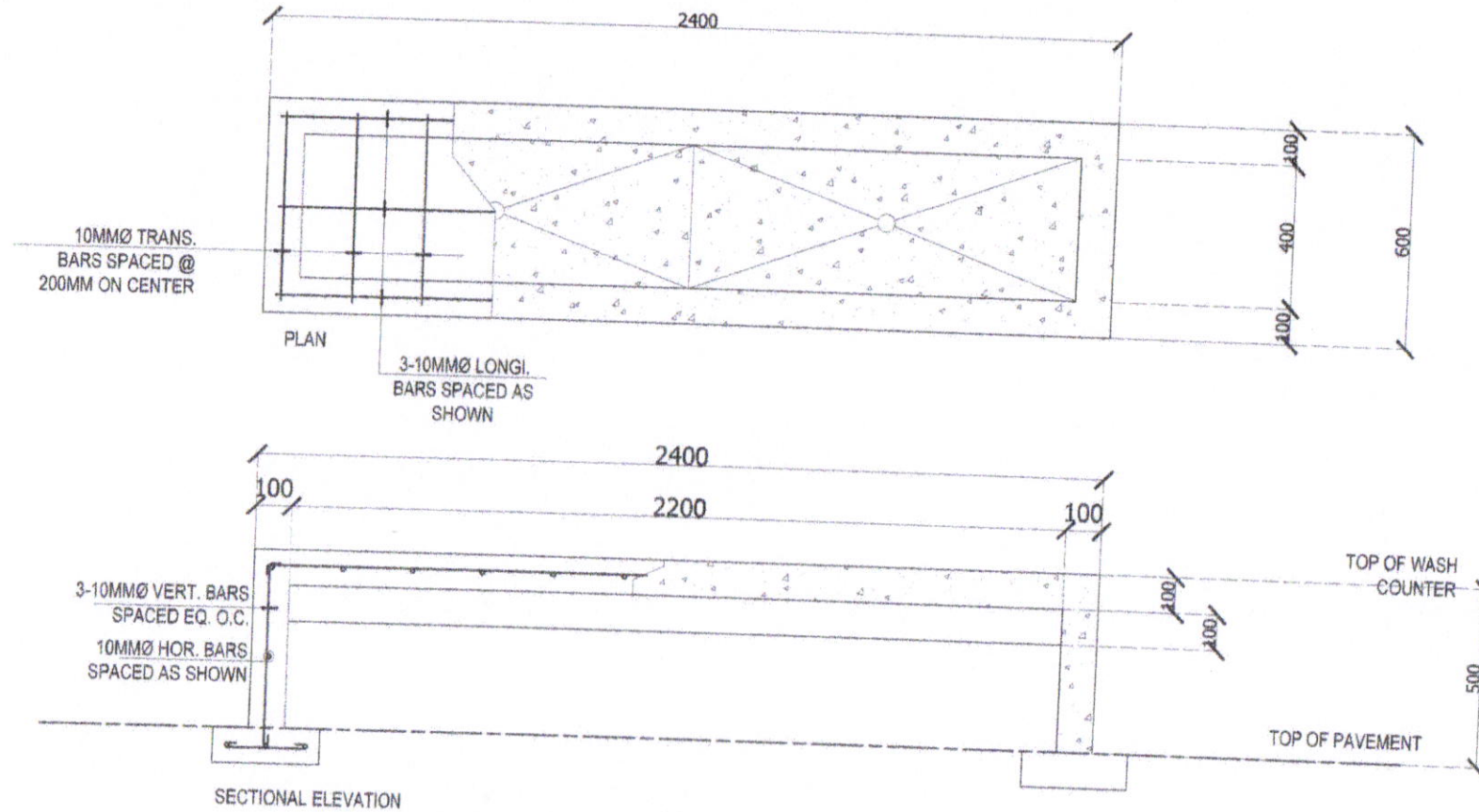

LEFT SIDE ELEVATION
SCALE : 1:100M.

PREPARED FROM:	PROJECT TITLE:	CADD:	RECOMMENDED BY:	APPROVED BY:
<p>CITY ENGINEER'S OFFICE</p>  <p>SORSOGON CITY CITY ENGINEER'S OFFICE</p>	<p>CONSTRUCTION/ REPAIR / IMPROVEMENT OF DAYCARE</p> <p>LOCATION: BRGY. SUGOD, BACON DISTRICT, SORSOGON CITY</p>	<p>ROWANFARBELLA DRAFTSMAN III</p>	<p><i>[Signature]</i> ROSEL B. DOMER C.E. / RMP OIC- CITY ENGINEER</p>	<p>HON. MA. ESTER E. HAMOR CITY MAYOR</p>



DETAIL OF HANDWASH COUNTER
 SCALE : 1:20M.

PREPARED FROM:	PROJECT TITLE:	CADD:	RECOMMENDED BY:	APPROVED BY:
 <p>SORSOGON CITY CITY ENGINEER'S OFFICE</p>	<p>CONSTRUCTION/ REPAIR / IMPROVEMENT OF DAYCARE</p> <p>LOCATION: BRGY. SUGOD, BACON DISTRICT, SORSOGON CITY</p>	<p>ROWANFMARBELLA DRAFTSMAN III</p>	 <p>ROBERT D. DOMEZ C.E. / RMP OIC- CITY ENGINEER</p>	<p>HON. MA. ESTER E. HAMOR CITY MAYOR</p>

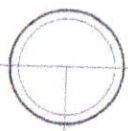
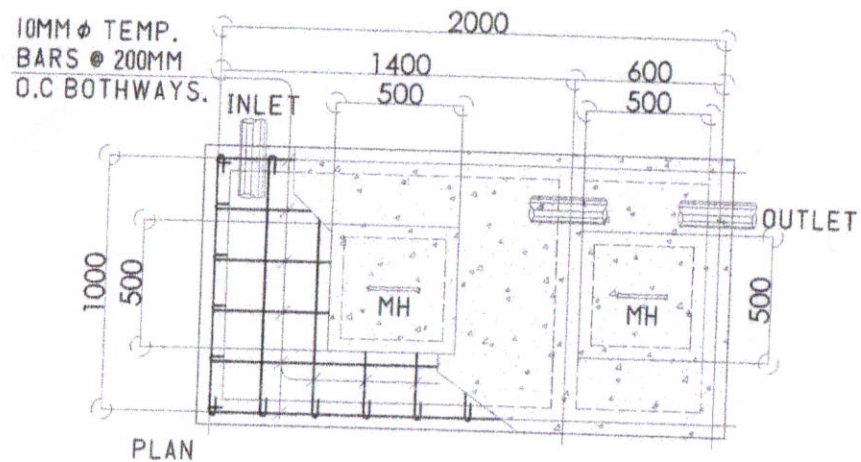

SEPTIC TANK DETAIL

SCALE:

1:40 MTS.

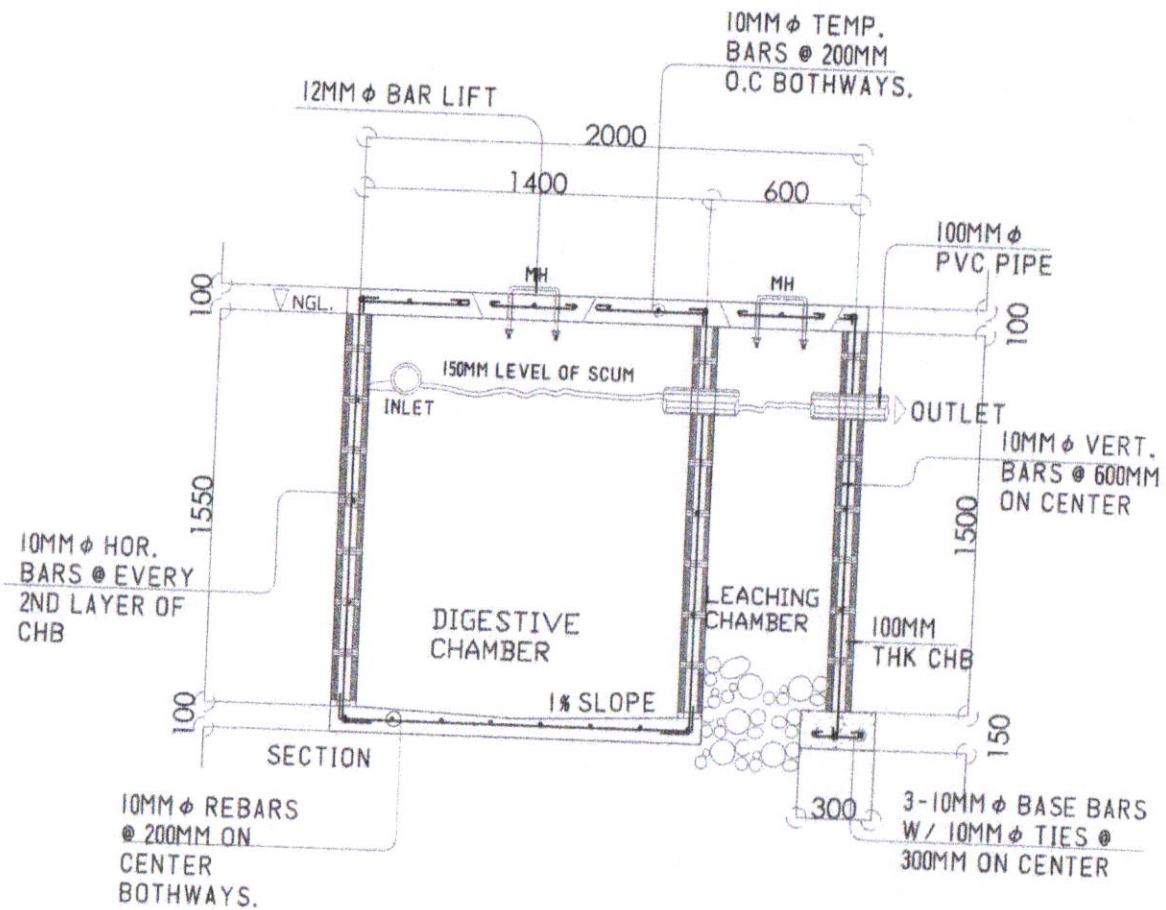

PREPARED FROM:

PROJECT TITLE:

CADD:

RECOMMENDED BY:

APPROVED BY:

CITY ENGINEER'S OFFICE

**CONSTRUCTION/ REPAIR /
IMPROVEMENT OF DAYCARE**

LOCATION: BRGY. SUGOD, BACON DISTRICT, SORSOGON CITY

ROWANFARBELLA

DRAFTSMAN III

ROEL B. DOMER, CE. / RMP

OIC- CITY ENGINEER

HON. MA. ESTER E. HAMOR

CITY MAYOR

SORSOGON CITY
CITY ENGINEER'S OFFICE

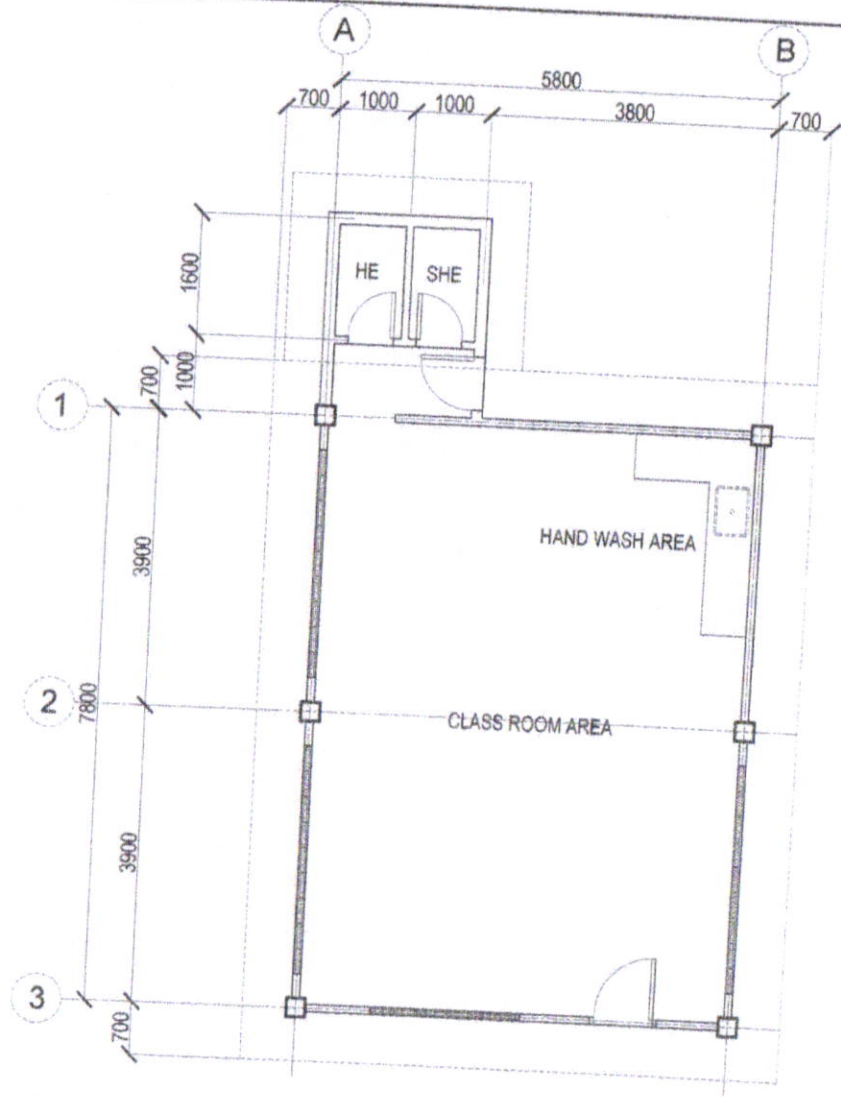

FLOOR PLAN
SCALE: 1:100M.

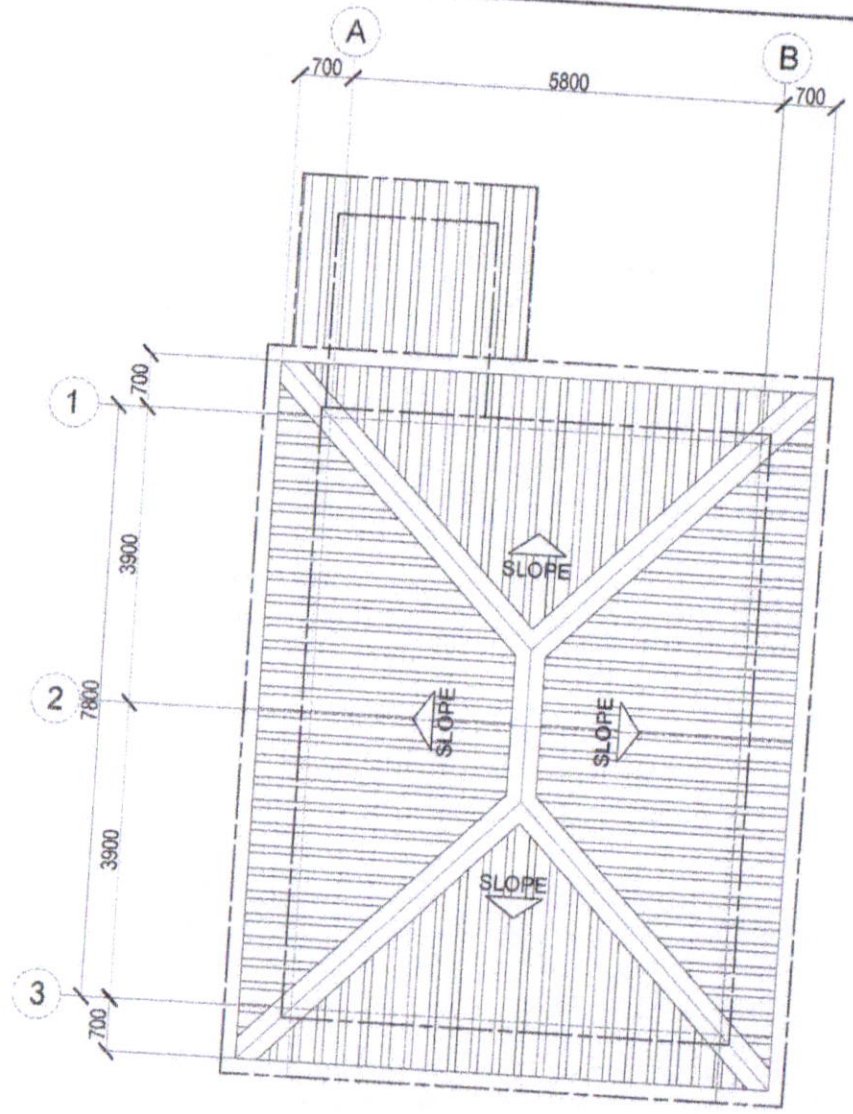

ROOF PLAN
SCALE: 1:100M.

PREPARED FROM:	PROJECT TITLE:	CADD:	RECOMMENDED BY:	APPROVED BY:
<p>CITY ENGINEER'S OFFICE</p>  <p>SORSOGON CITY CITY ENGINEER'S OFFICE</p>	<p>CONSTRUCTION/ REPAIR / IMPROVEMENT OF DAYCARE</p> <p>LOCATION: BRGY. SAN RAMON, BACON DISTRICT, SORSOGON CITY</p>	<p>ROWANF MARBELLA DRAFTSMAN III</p>	<p><i>[Signature]</i> ROEL B. DOMER C.E. / RMP OIC - CITY ENGINEER</p>	<p>HON. MA. ESTER E. HAMOR CITY MAYOR</p>

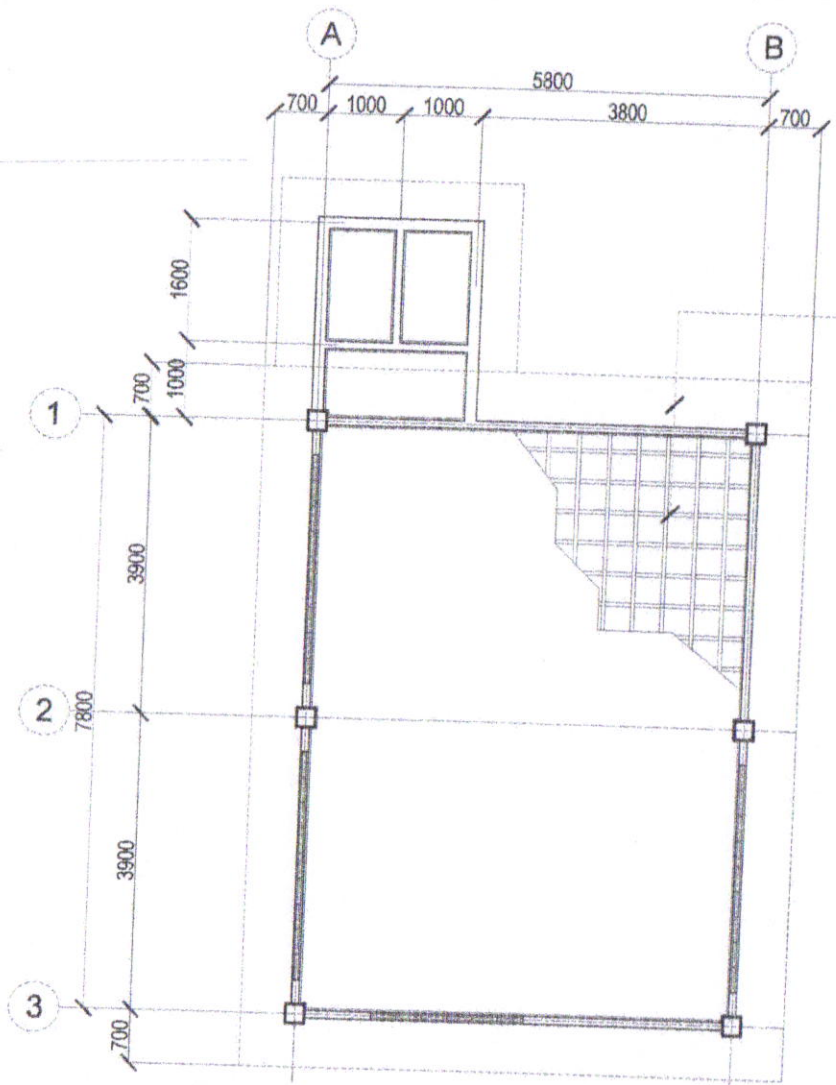

REFLECTED CEILING PLAN
SCALE: 1:100M.

4.6MM THK FICEM BOARD ON METAL FURRING CEILING JOIST SPACED @ 400MM ON CENTER BOTHWAYS.

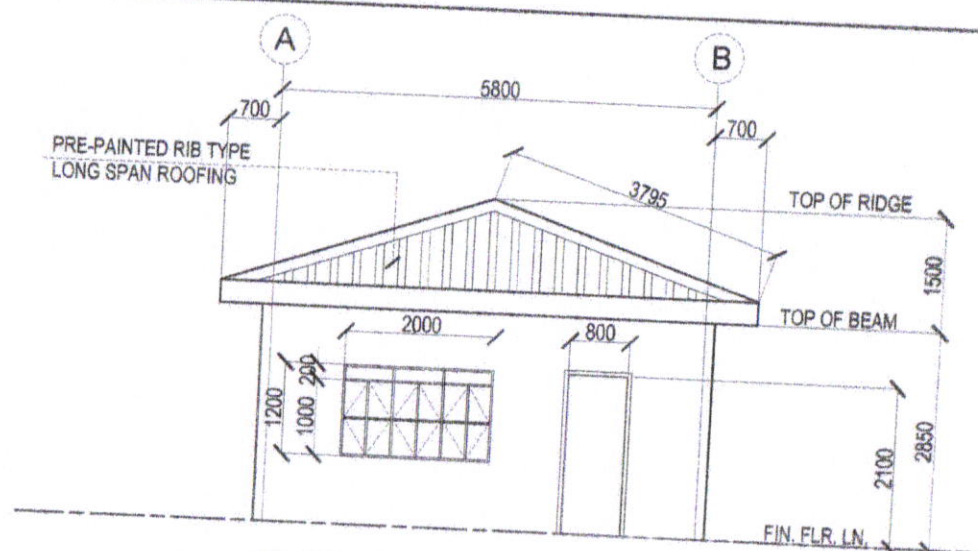

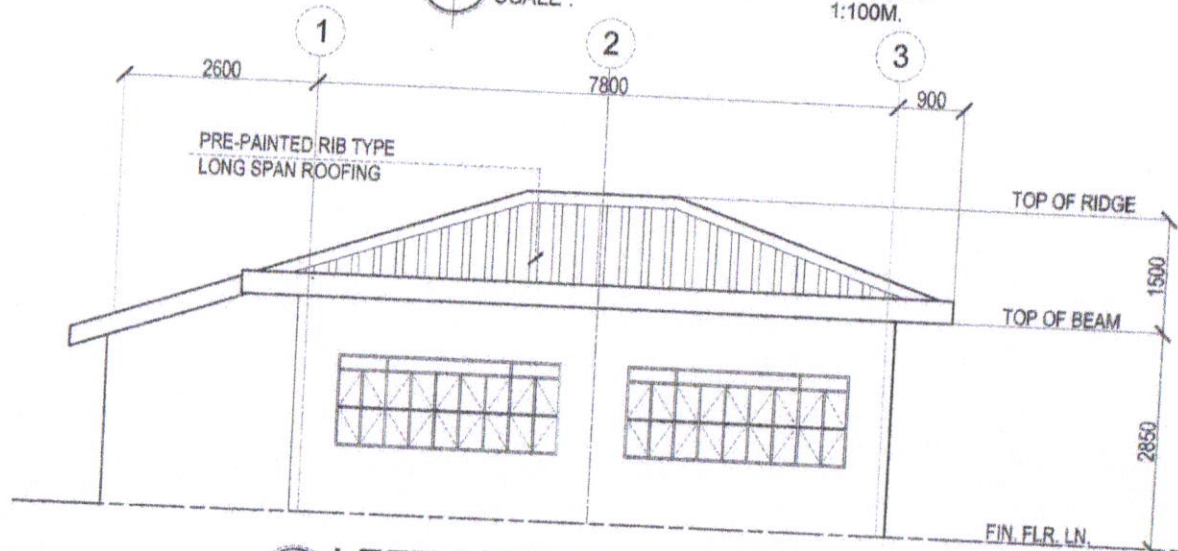

FRONT ELEVATION
SCALE: 1:100M.

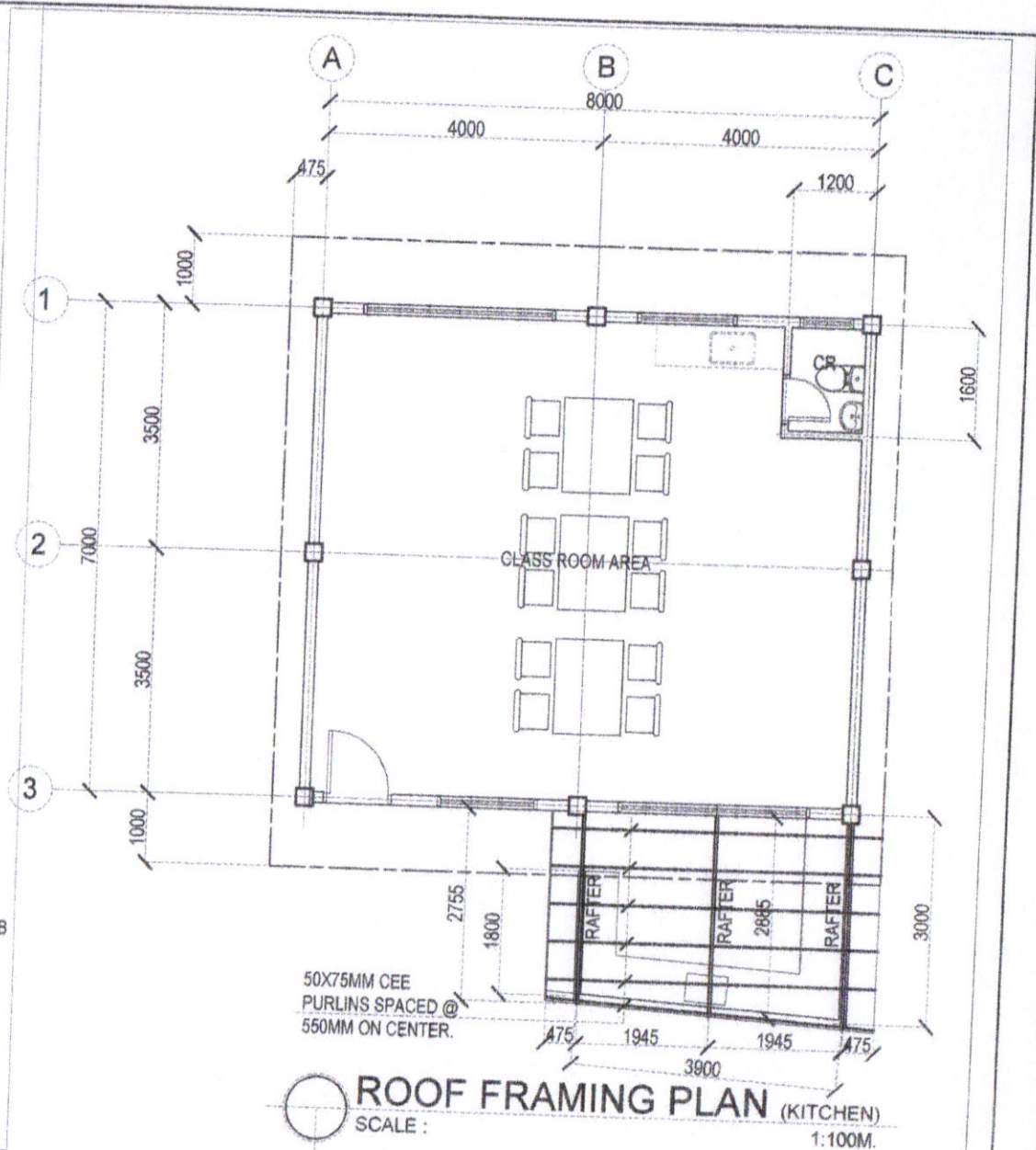
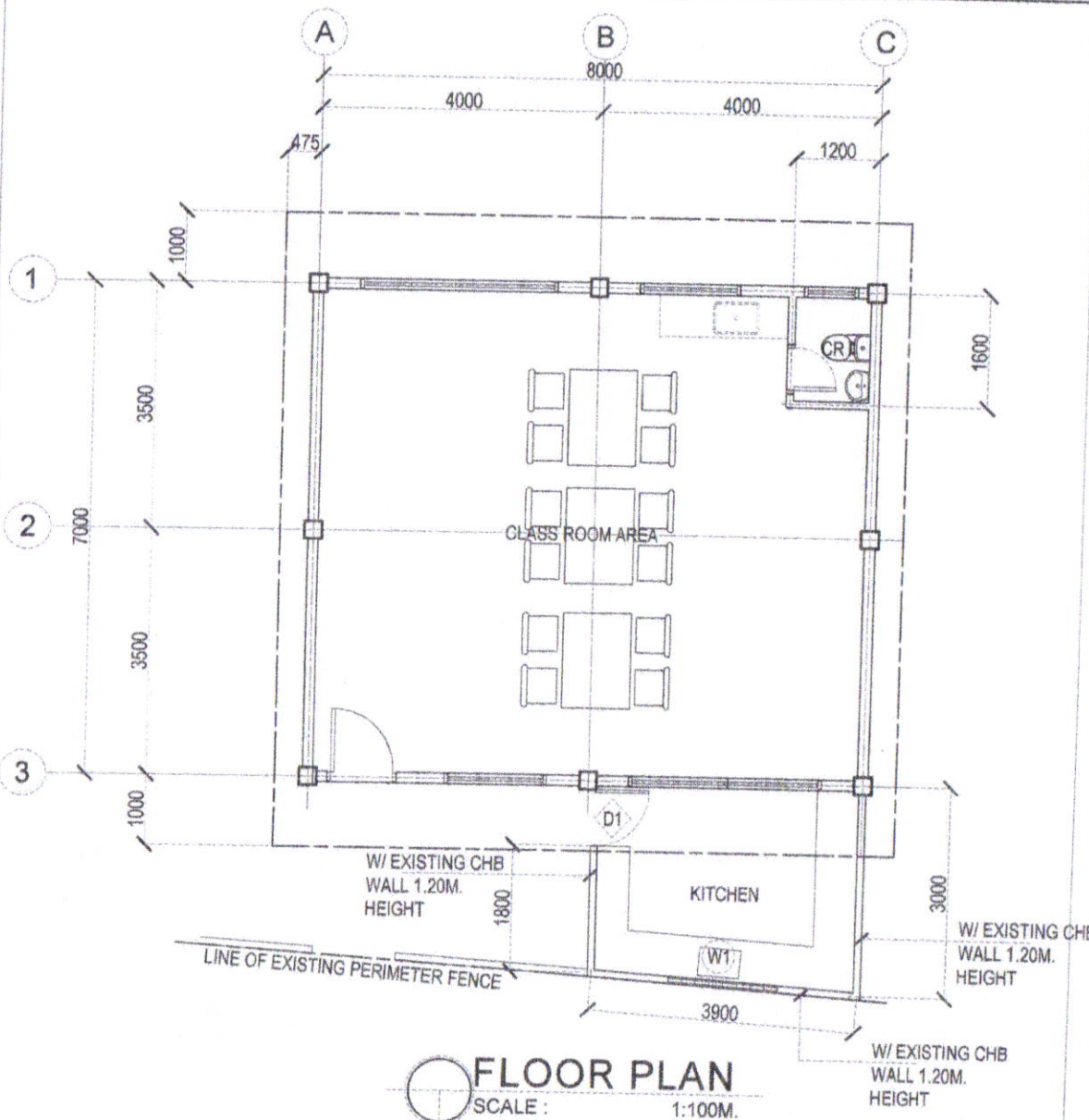

LEFT SIDE ELEVATION
SCALE: 1:100M.

PREPARED FROM:	PROJECT TITLE:	CADD:	RECOMMENDED BY:	APPROVED BY:
 SORSOGON CITY CITY ENGINEER'S OFFICE	CONSTRUCTION/ REPAIR / IMPROVEMENT OF DAYCARE			
	LOCATION: BRGY. SAN RAMON, BACON DISTRICT, SORSOGON CITY	ROWANFMARBELLA DRAFTSMAN III	ROEL D. BOMER C.P. / RMP OIC-CITY ENGINEER	HON. MA. ESTER E. HAMOR CITY MAYOR

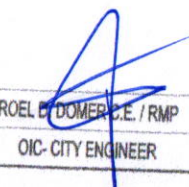

PREPARED FROM:	PROJECT TITLE:	CADD:	RECOMMENDED BY:	APPROVED BY:
CITY ENGINEER'S OFFICE  SORSOGON CITY CITY ENGINEER'S OFFICE	CONSTRUCTION/ REPAIR / IMPROVEMENT OF DAYCARE LOCATION: BRGY. SAN ROQUE, BACON DISTRICT, SORSOGON CITY	ROWANF MARBELLA DRAFTSMAN III	 ROEL B. DOMEZ, C.E. / RMP OIC- CITY ENGINEER	HON. MA. ESTER E. HAMOR CITY MAYOR

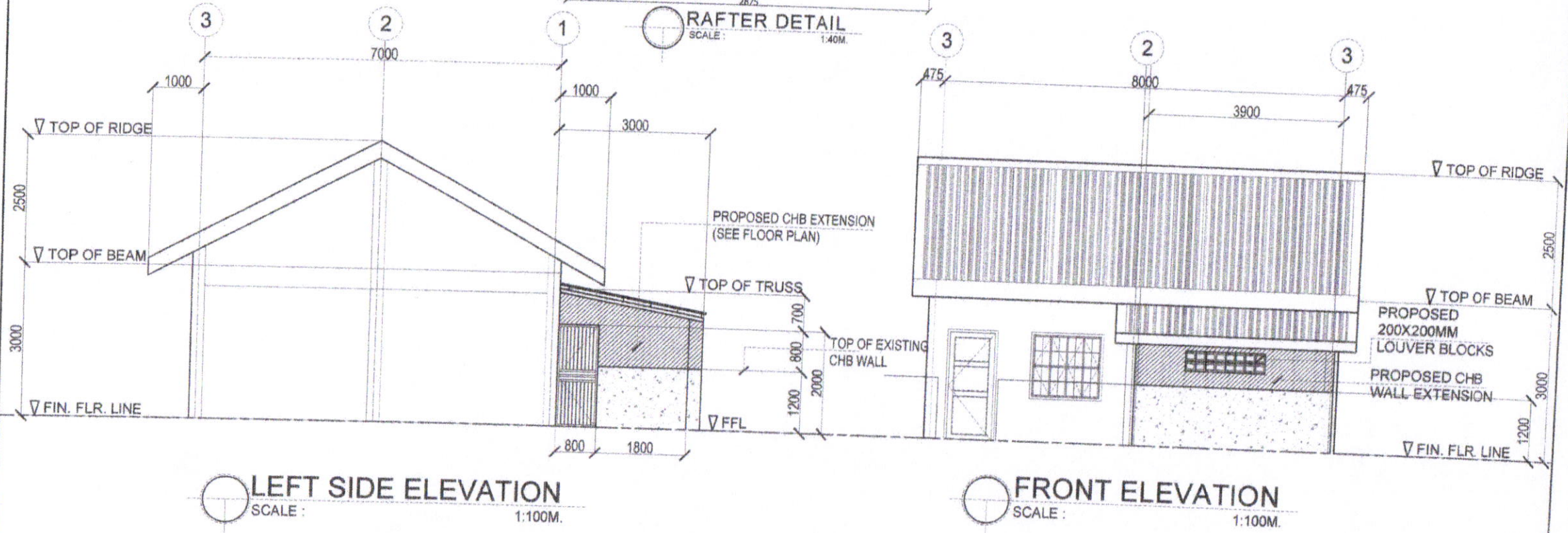
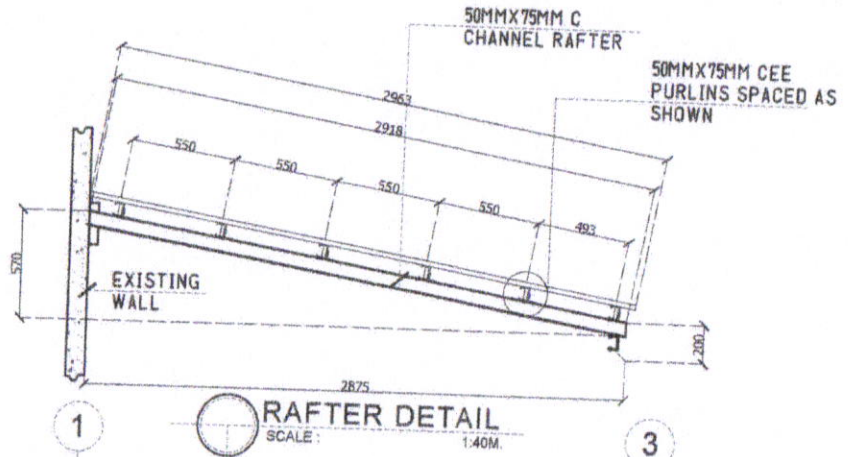

PREPARED FROM:	PROJECT TITLE:	CADD:	RECOMMENDED BY:	APPROVED BY:
CITY ENGINEER'S OFFICE	CONSTRUCTION/ REPAIR / IMPROVEMENT OF DAYCARE			
<p>SORSOGON CITY CITY ENGINEER'S OFFICE</p>	LOCATION: BRGY. SAN ROQUE, BACON DISTRICT, SORSOGON CITY	ROWANFMARBELLA DRAFTSMAN III	ROEL D. DOMER C.E. / RMP OIC-CITY ENGINEER	HON. MA. ESTER E. HAMOR CITY MAYOR

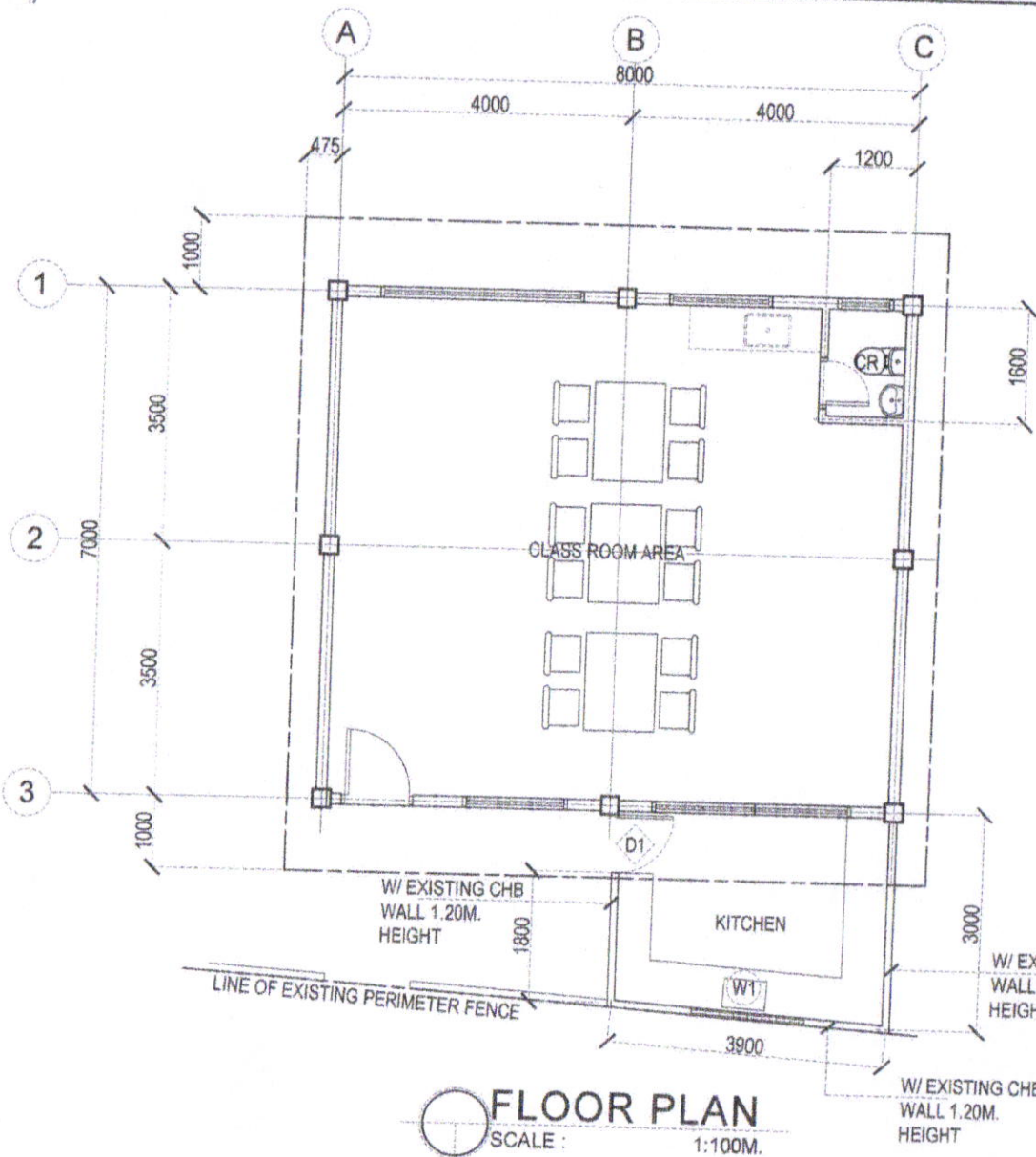

FLOOR PLAN
SCALE: 1:100M.

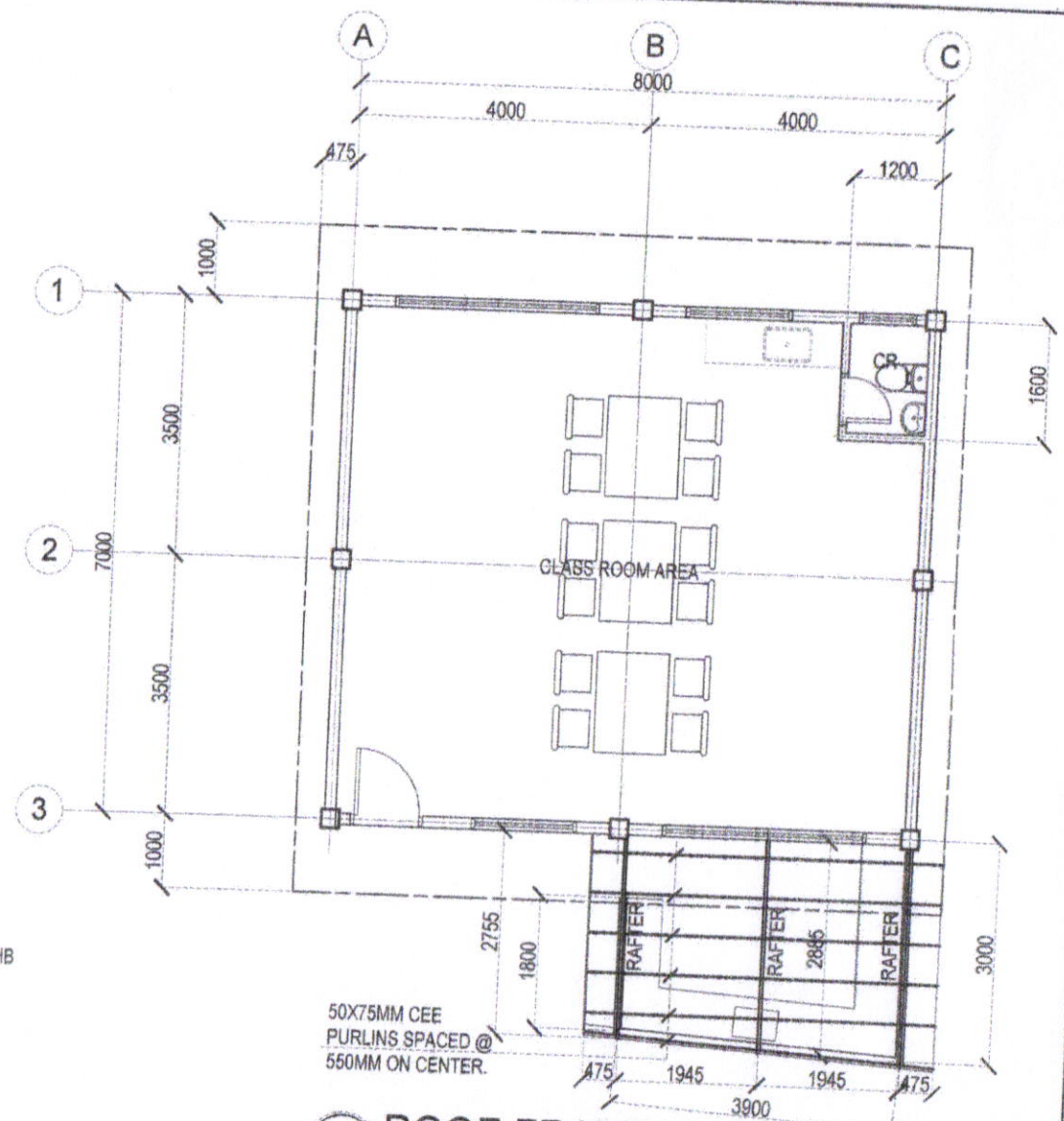

ROOF FRAMING PLAN (KITCHEN)
SCALE: 1:100M.

PREPARED FROM:	PROJECT TITLE:	CADD:	RECOMMENDED BY:	APPROVED BY:
<p>CITY ENGINEER'S OFFICE</p>  <p>SORSOGON CITY CITY ENGINEER'S OFFICE</p>	<p>CONSTRUCTION/ REPAIR / IMPROVEMENT OF DAYCARE</p> <p>LOCATION: BRGY. SAN ROQUE, BACON DISTRICT, SORSOGON CITY</p>	<p>ROWANFARBELLA DRAFTSMAN III</p>	<p>ROEL B. BOMER, C.E., RMP OIC- CITY ENGINEER</p>	<p>HON. MA. ESTER E. HAMOR CITY MAYOR</p>

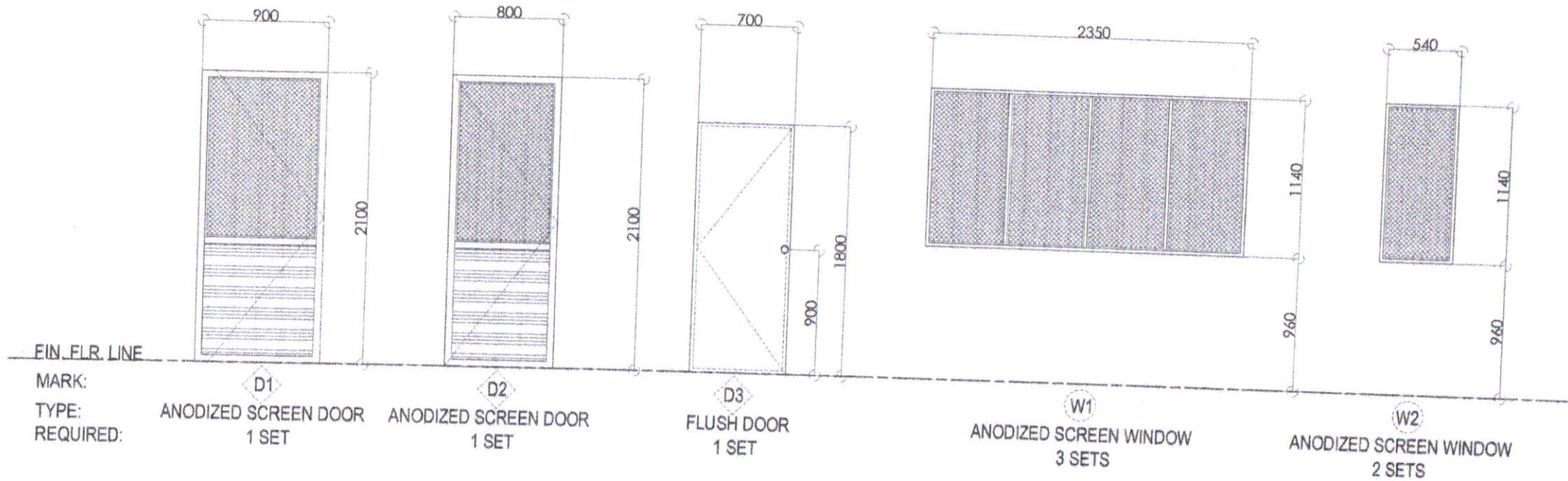

SCHEDULE OF SCREEN WINDOWS & DOORS

SCALE :

1:40M.

 <p>CITY ENGINEER'S OFFICE</p> <p>SORSOGON CITY CITY ENGINEER'S OFFICE</p>	PROJECT TITLE:	CADD:	RECOMMENDED BY:	APPROVED BY:
	<p>CONSTRUCTION/ REPAIR / IMPROVEMENT OF DAYCARE</p> <p>LOCATION: BRGY. BALETE, BACON DISTRICT, SORSOGON CITY</p>	<p>ROWANFMARBELLA DRAFTSMAN III</p>	<p>ROEL D. DOMER O.E. / RMP OIC - CITY ENGINEER</p>	<p>HON. MA. ESTER E. HAMOR CITY MAYOR</p>

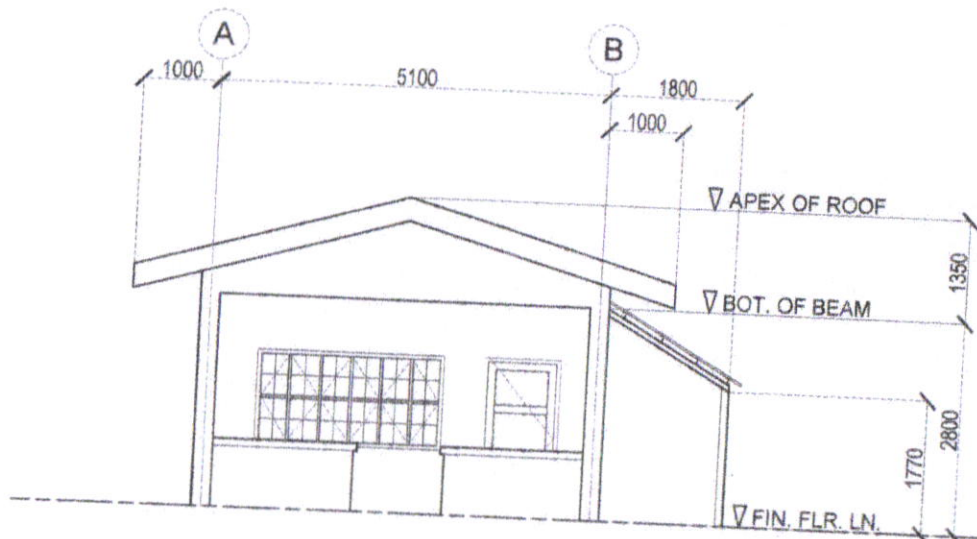

FRONT ELEVATION
SCALE : 1:100M.

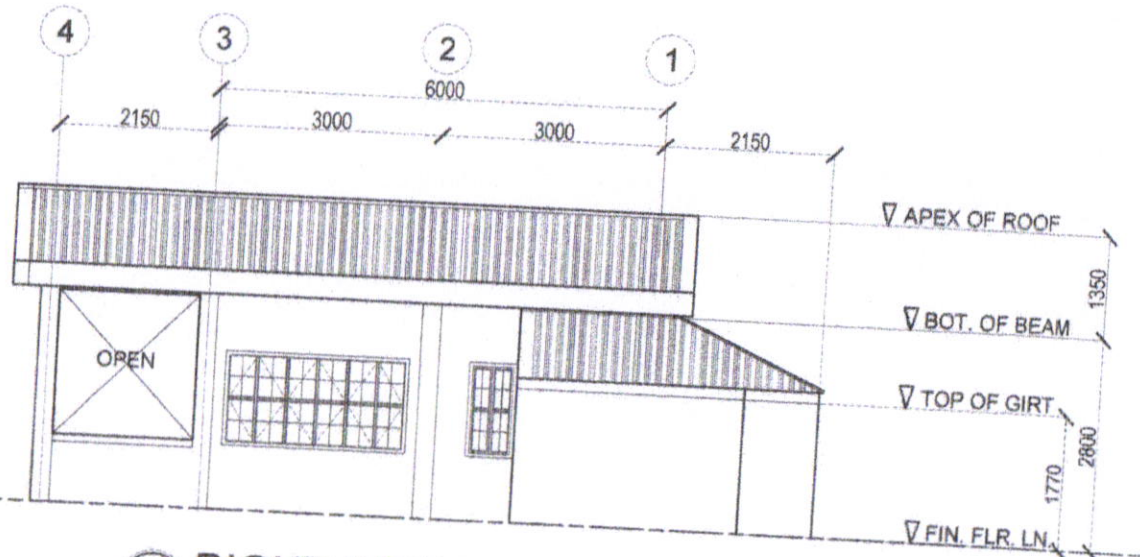

RIGHT SIDE ELEVATION
SCALE : 1:100M.

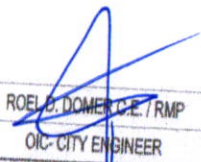
 SORSOGON CITY CITY ENGINEER'S OFFICE	PROJECT TITLE:	CADD:	RECOMMENDED BY:	APPROVED BY:
	CONSTRUCTION/ REPAIR / IMPROVEMENT OF DAYCARE LOCATION: BRGY. BALETE, BACON DISTRICT, SORSOGON CITY	ROWANFMARBELLA DRAFTSMAN III	 ROEL B. DOMEZ C.E./RMP OIC-CITY ENGINEER	HON. MA. ESTER E. HAMOR CITY MAYOR

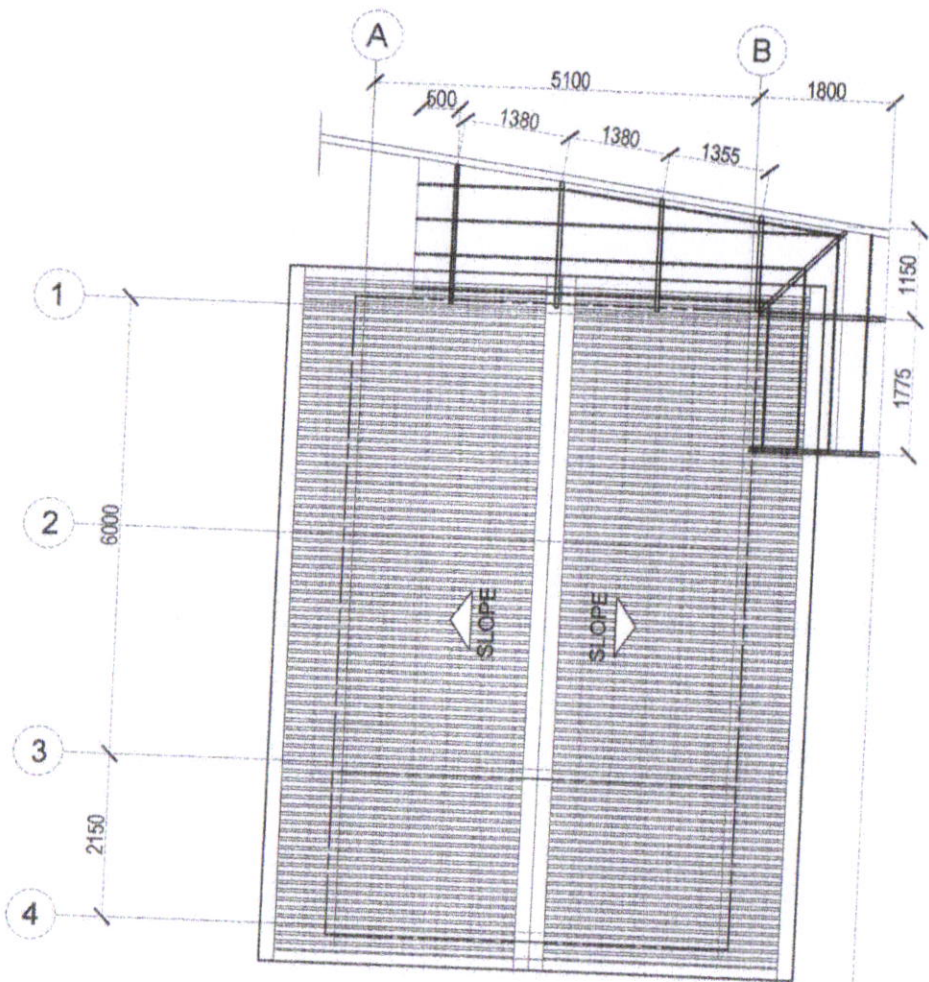

ROOF/ FRAMING PLAN
SCALE : 1:100M.

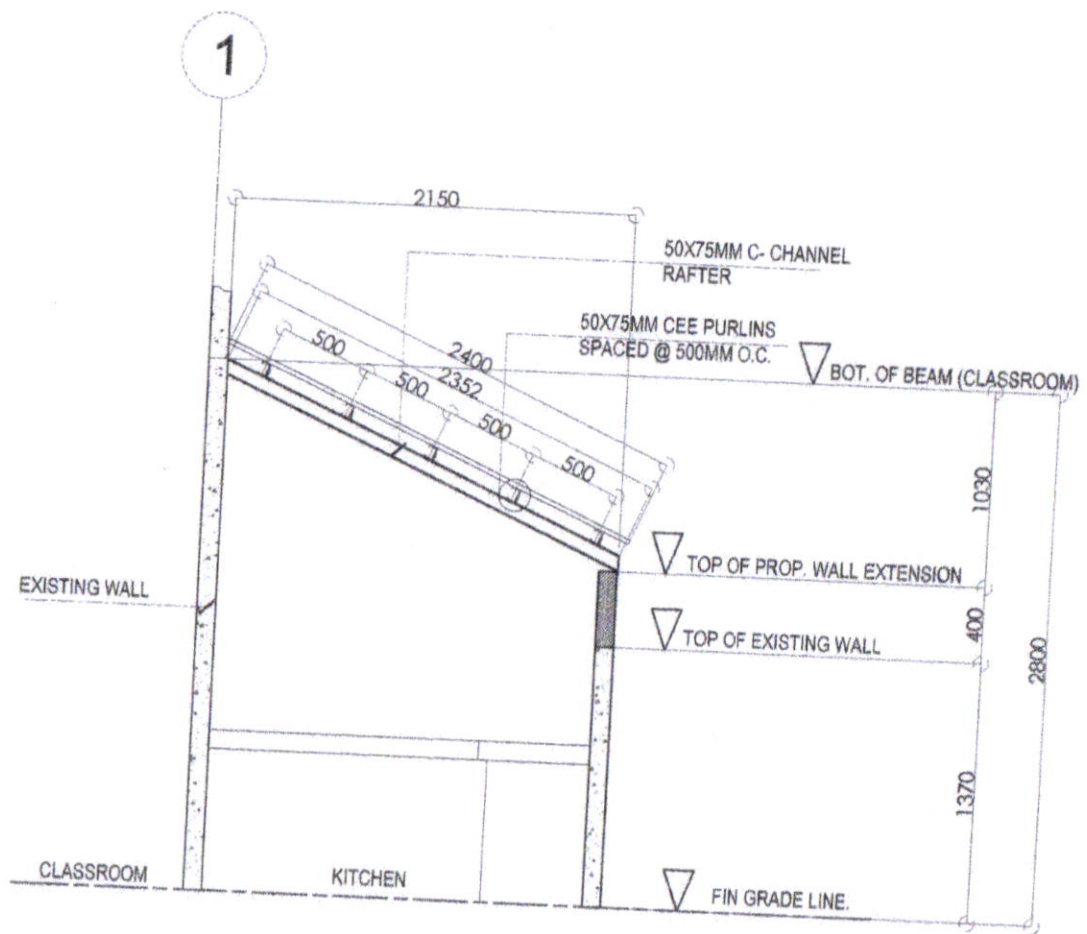

RAFTER DETAIL
SCALE : 1:40M.

CITY ENGINEER'S OFFICE



SORSOGON CITY
CITY ENGINEER'S OFFICE

PROJECT TITLE:

**CONSTRUCTION/ REPAIR /
IMPROVEMENT OF DAYCARE**

LOCATION: BRGY. BALETE, BACON DISTRICT, SORSOGON CITY

CADD:

ROWANFARBELLA
DRAFTSMAN III

RECOMMENDED BY:

ROEL B. DOMERCE / RMP
OIC-CITY ENGINEER

APPROVED BY:

HON. MA. ESTER E. HAMOR
CITY MAYOR

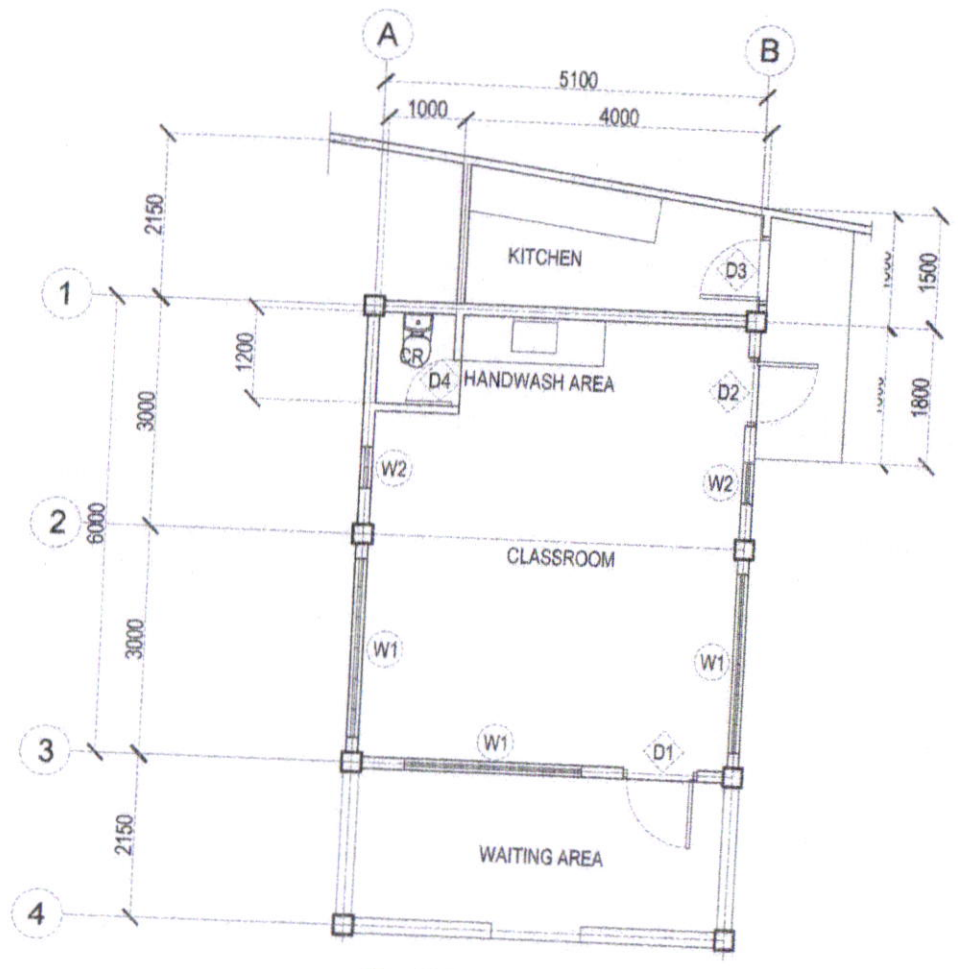

FLOOR PLAN
SCALE: 1:100M.

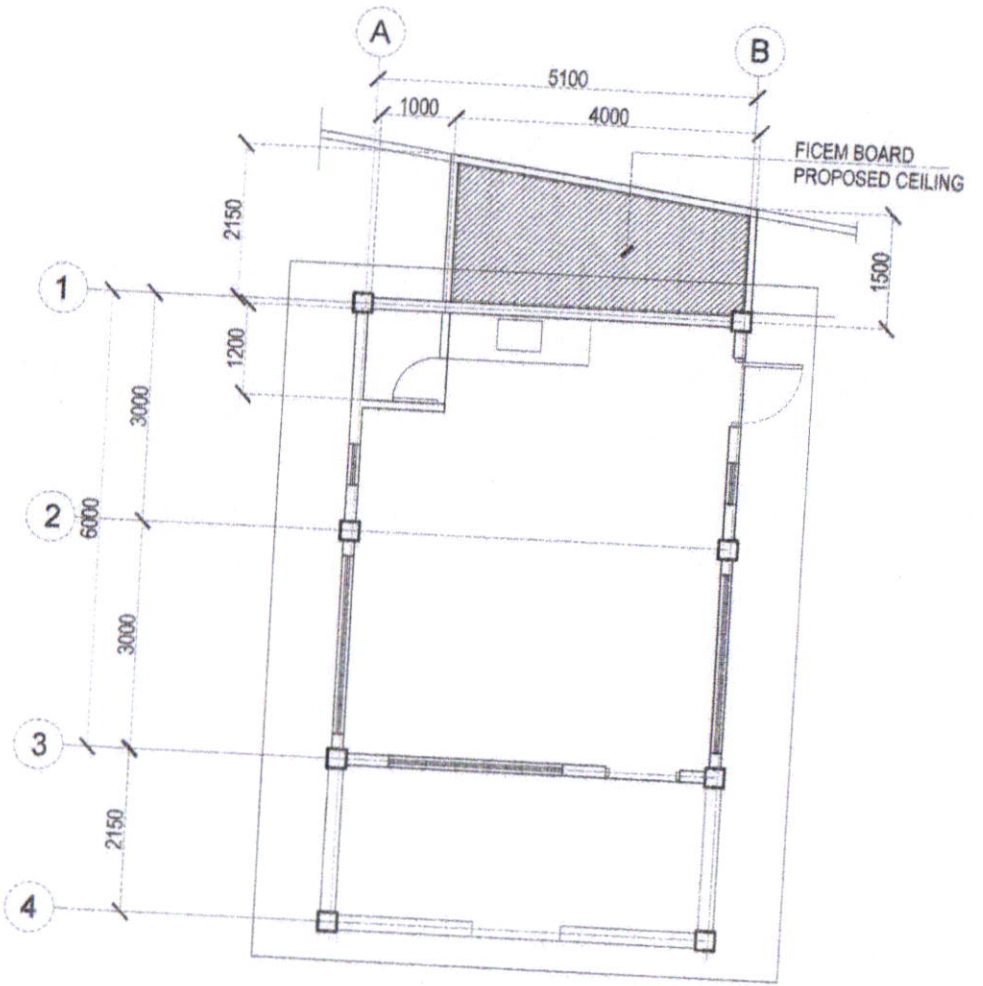

REFLECTED CEILING PLAN
SCALE: 1:100M.

CITY ENGINEER'S OFFICE



SORSOGON CITY
CITY ENGINEER'S OFFICE

PROJECT TITLE:
**CONSTRUCTION/ REPAIR /
IMPROVEMENT OF DAYCARE**
LOCATION: BRGY. BALETE, BACON DISTRICT, SORSOGON CITY

CADD:
ROWANFMARBELLA
DRAFTSMAN III

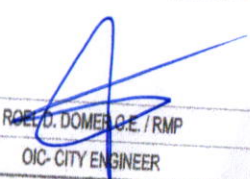
RECOMMENDED BY:

ROEL D. DOMEZ, C.E. / RMP
OIC-CITY ENGINEER

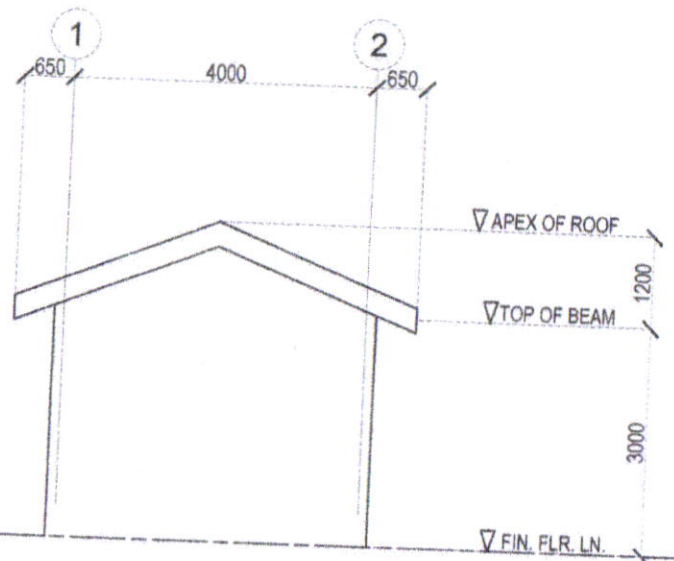
APPROVED BY:
HON. MA. ESTER E. HAMOR
CITY MAYOR

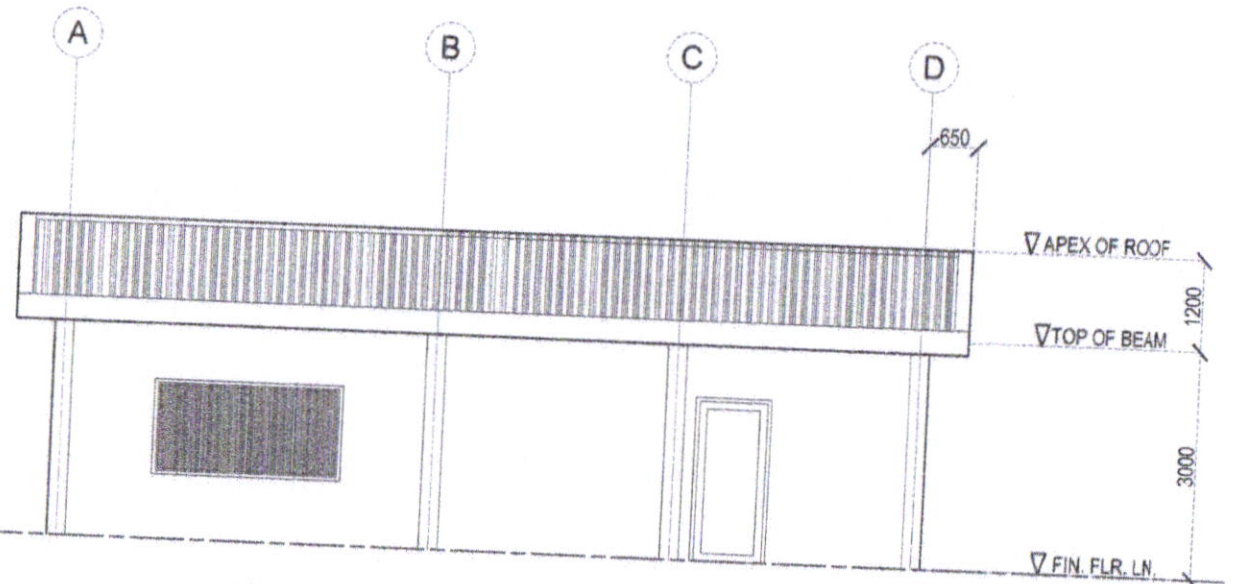

TYPICAL SIDE ELEVATION
SCALE : 1:100M.



FRONT ELEVATION
SCALE : 1:100M.

CITY ENGINEER'S OFFICE

SORSOGON CITY
CITY ENGINEER'S OFFICE

PROJECT TITLE:
**CONSTRUCTION/ REPAIR /
 IMPROVEMENT OF DAYCARE**

LOCATION: BRGY. BATO, BACON DISTRICT, SORSOGON CITY

CADD:
 ROWANFARBELLA
 DRAFTSMAN III

RECOMMENDED BY:

 ROWANFARBELLA
 OIC- CITY ENGINEER

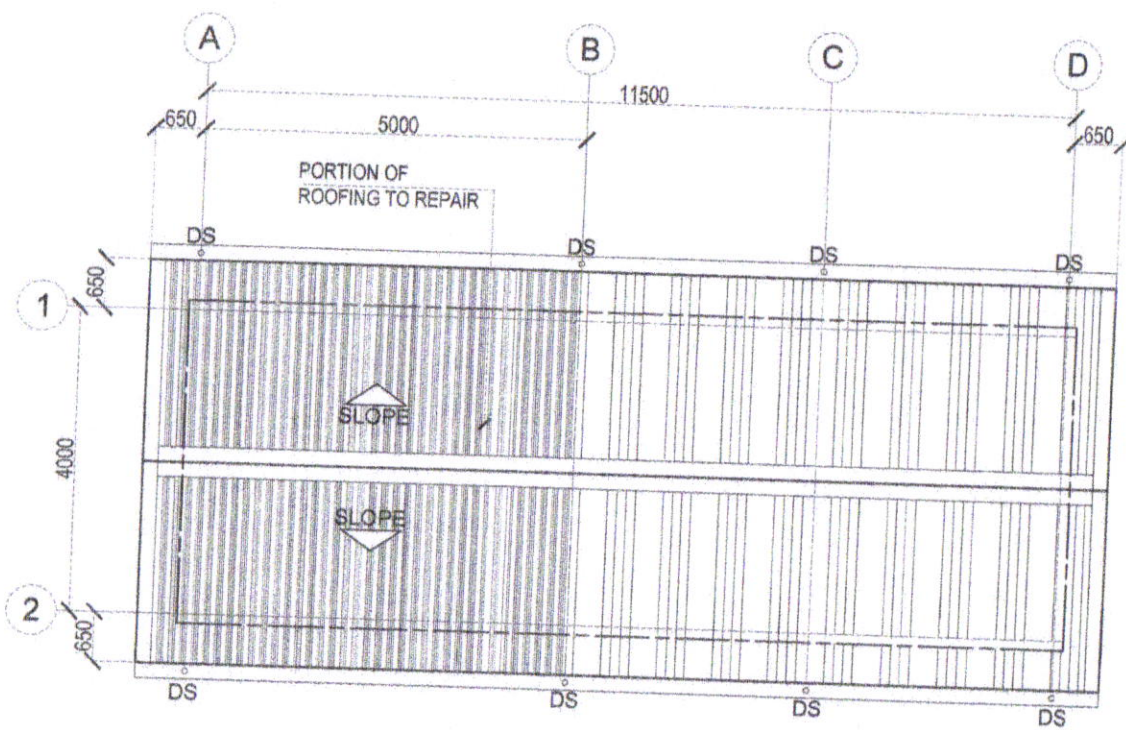
APPROVED BY:
 HON. MA. ESTER E. HAMOR
 CITY MAYOR

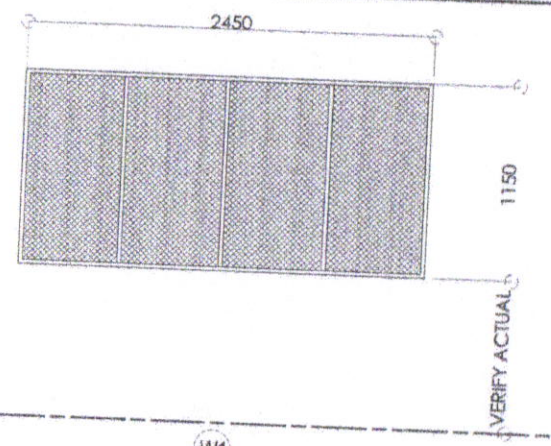

ROOF PLAN
SCALE : 1:100M.



FIN. FLR. LINE
MARK: W1
TYPE: ANODIZED SCREEN WINDOW
REQUIRED: 1 SET

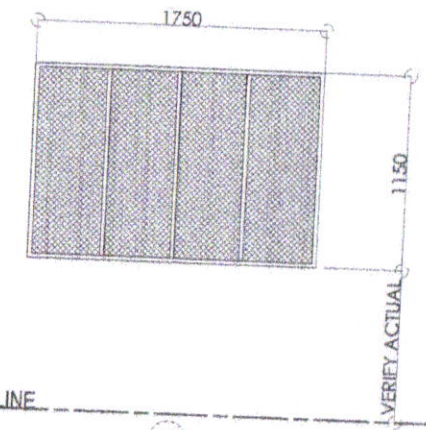



FIN. FLR. LINE
MARK: W2
TYPE: ANODIZED SCREEN WINDOW
REQUIRED: 1 SET

SCHEDULE OF SCREEN WINDOWS
SCALE : 1:45M.

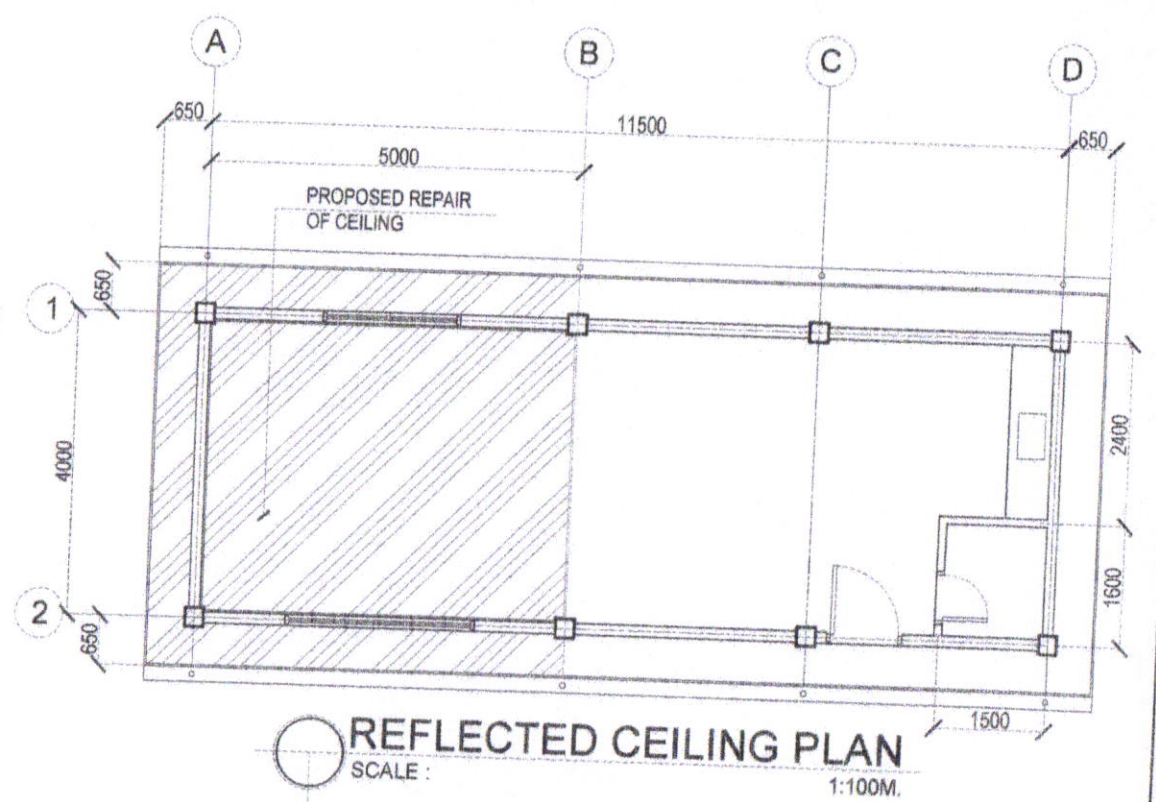
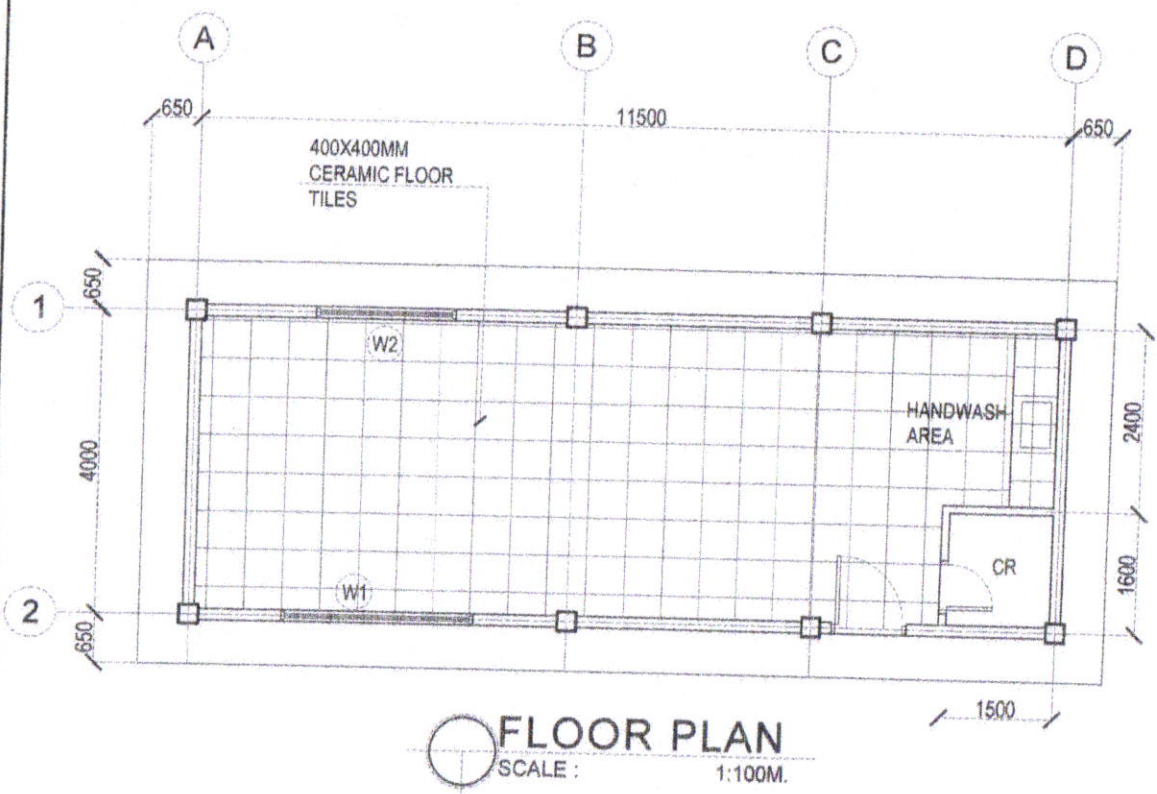
CITY ENGINEER'S OFFICE  SORSOGON CITY CITY ENGINEER'S OFFICE	PROJECT TITLE:	CADD:	RECOMMENDED BY:	APPROVED BY:
	CONSTRUCTION/ REPAIR / IMPROVEMENT OF DAYCARE			
	LOCATION: BRGY. BATO, BACON DISTRICT, SORSOGON CITY	ROWANF MARBELLA DRAFTSMAN III	ROEL D. DOMER G.E. / RMP OIC- CITY ENGINEER	HON. MA. ESTER E. HAMOR CITY MAYOR



 <p>SORSOGON CITY CITY ENGINEER'S OFFICE</p>	PROJECT TITLE: CONSTRUCTION/ REPAIR / IMPROVEMENT OF DAYCARE	CADD:	RECOMMENDED BY:	APPROVED BY:
	LOCATION: BRGY. BATO, BACON DISTRICT, SORSOGON CITY	ROWANFARBELLA DRAFTSMAN III	 ROWEL D. DOMER C.E. / RMP OIC- CITY ENGINEER	HON. MA. ESTER E. HAMOR CITY MAYOR

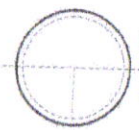
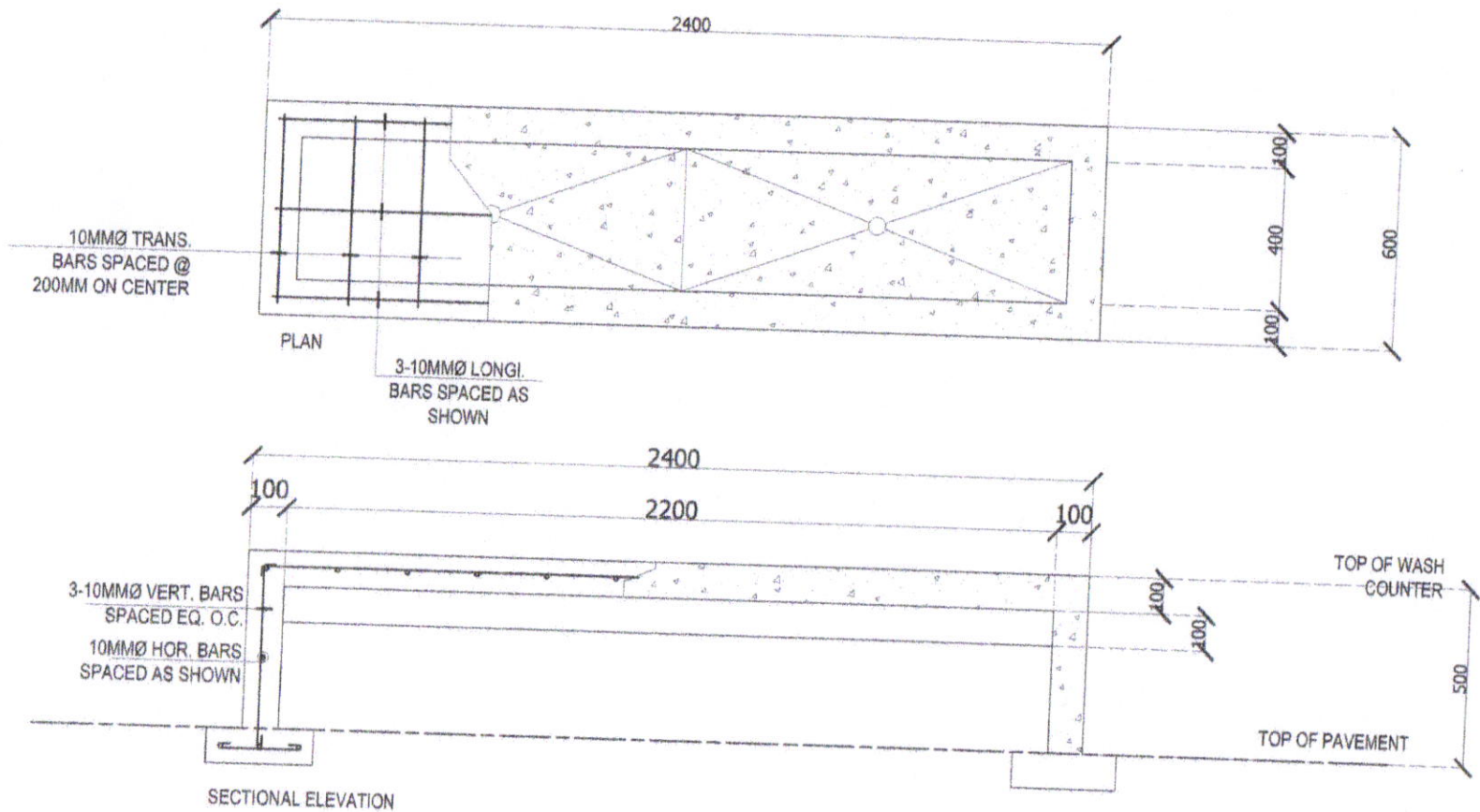

DETAIL OF HANDWASH COUNTER

SCALE :

1:15M.

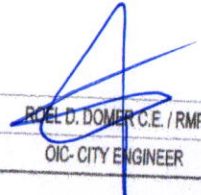
CITY ENGINEER'S OFFICE  SORSOGON CITY CITY ENGINEER'S OFFICE	PROJECT TITLE:	CADD:	RECOMMENDED BY:	APPROVED BY:
	CONSTRUCTION/ REPAIR / IMPROVEMENT OF DAYCARE LOCATION: BRGY. LUCIA, BACON DISTRICT, SORSOGON CITY	ROWANFMARBELLA DRAFTSMAN III	 ROEL D. DOMEZ C.E. / RMP OIC- CITY ENGINEER	HON. MA. ESTER E. HAMOR CITY MAYOR

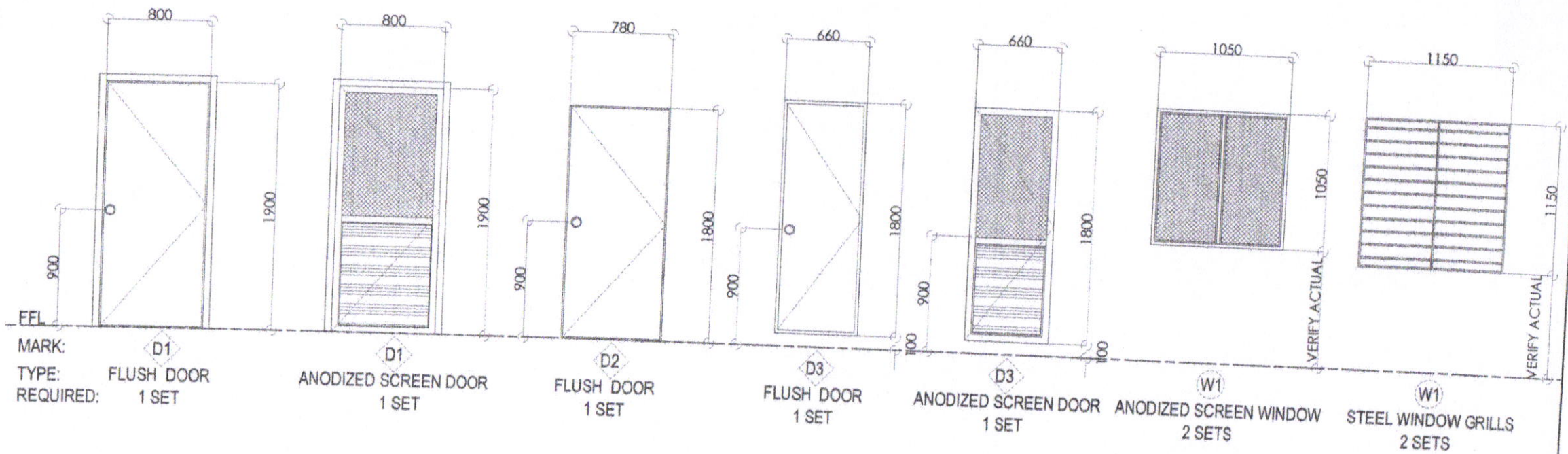

SCHEDULE OF SCREEN WINDOWS
 SCALE : 1:40M.

CITY ENGINEER'S OFFICE  SORSOGON CITY CITY ENGINEER'S OFFICE	PROJECT TITLE:	CADD:	RECOMMENDED BY:	APPROVED BY:
	CONSTRUCTION/ REPAIR / IMPROVEMENT OF DAYCARE LOCATION: BRGY. LUCIA, BACON DISTRICT, SORSOGON CITY	ROWANF MARBELLA DRAFTSMAN III	ROEL D. DOMER, C.E. / RMP OIC- CITY ENGINEER	HON. MA. ESTER E. HAMOR CITY MAYOR

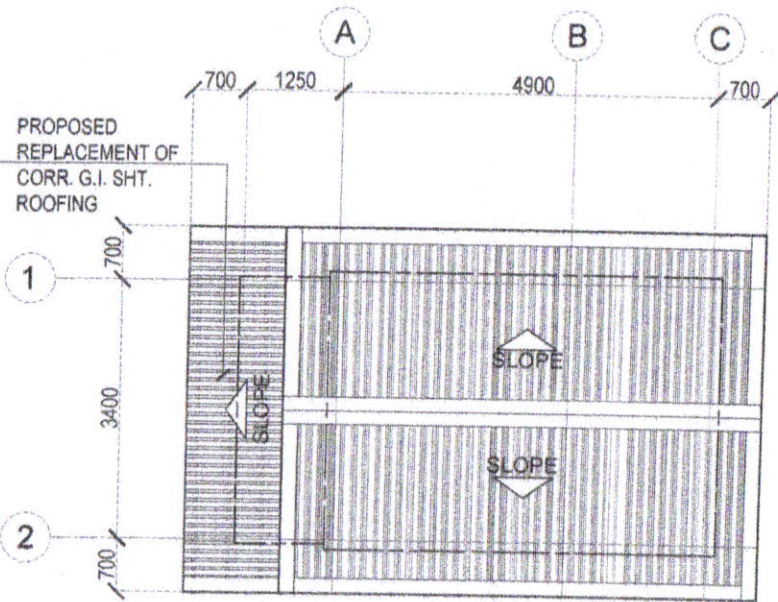

ROOF PLAN
SCALE: 1:100M.

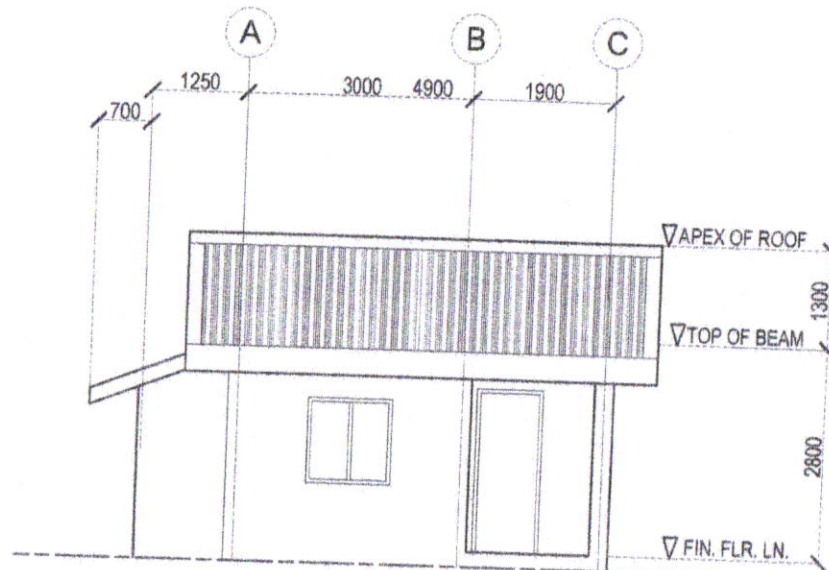

TYPICAL SIDE ELEVATION
SCALE: 1:100M.

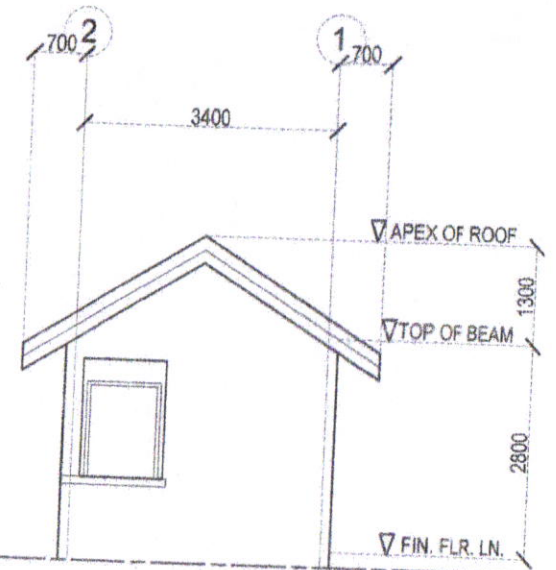

FRONT ELEVATION
SCALE: 1:100M.

CITY ENGINEER'S OFFICE



SORSOGON CITY
CITY ENGINEER'S OFFICE

PROJECT TITLE:

**CONSTRUCTION/ REPAIR /
IMPROVEMENT OF DAYCARE**

LOCATION: BRGY. LUCIA, BACON DISTRICT, SORSOGON CITY

CADD:

ROWANFARBELLA
DRAFTSMAN III

RECOMMENDED BY:

ROEL D. DOMER, C.E. / R.M.P.
OIC, CITY ENGINEER

APPROVED BY:

HON. MA. ESTER E. HAMOR
CITY MAYOR

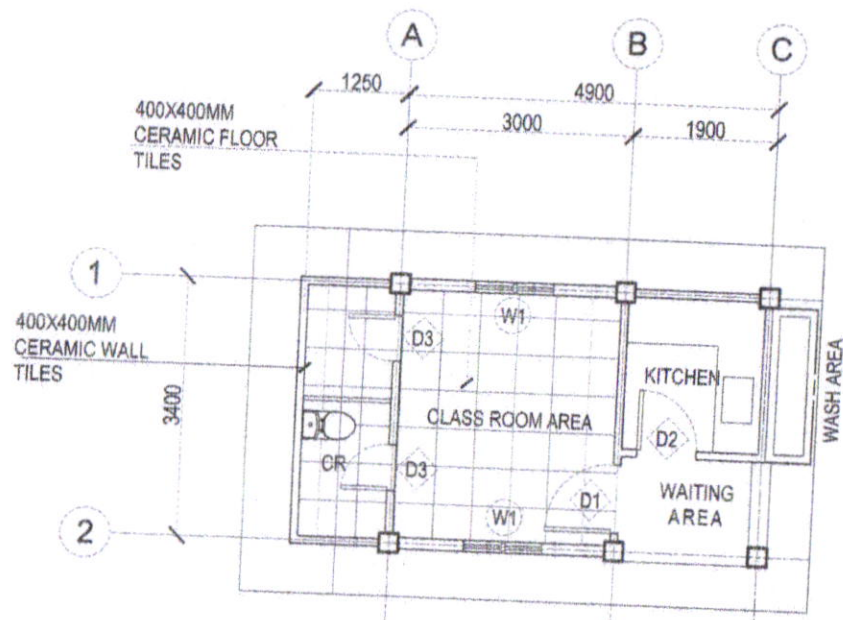

FLOOR PLAN
SCALE: 1:100M.

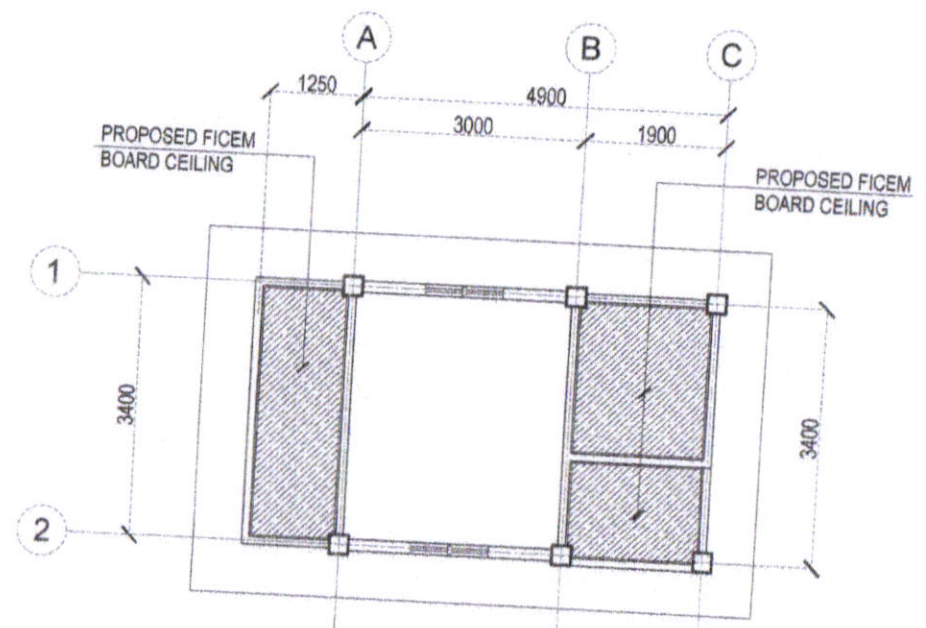

REFLECTED CEILING PLAN
SCALE: 1:100M.

CITY ENGINEER'S OFFICE

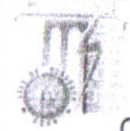

SORSOGON CITY
CITY ENGINEER'S OFFICE

PROJECT TITLE:

**CONSTRUCTION/ REPAIR /
IMPROVEMENT OF DAYCARE**

LOCATION: BRGY. STA. LUCIA, BACON DISTRICT, SORSOGON CITY

CADD:

ROWANFARBELLA
DRAFTSMAN III

RECOMMENDED BY:

[Signature]
ROEL B. DOMER, C.E. / R.M.P.
CIC CITY ENGINEER

APPROVED BY:

HON. MA. ESTER E. HAMOR
CITY MAYOR

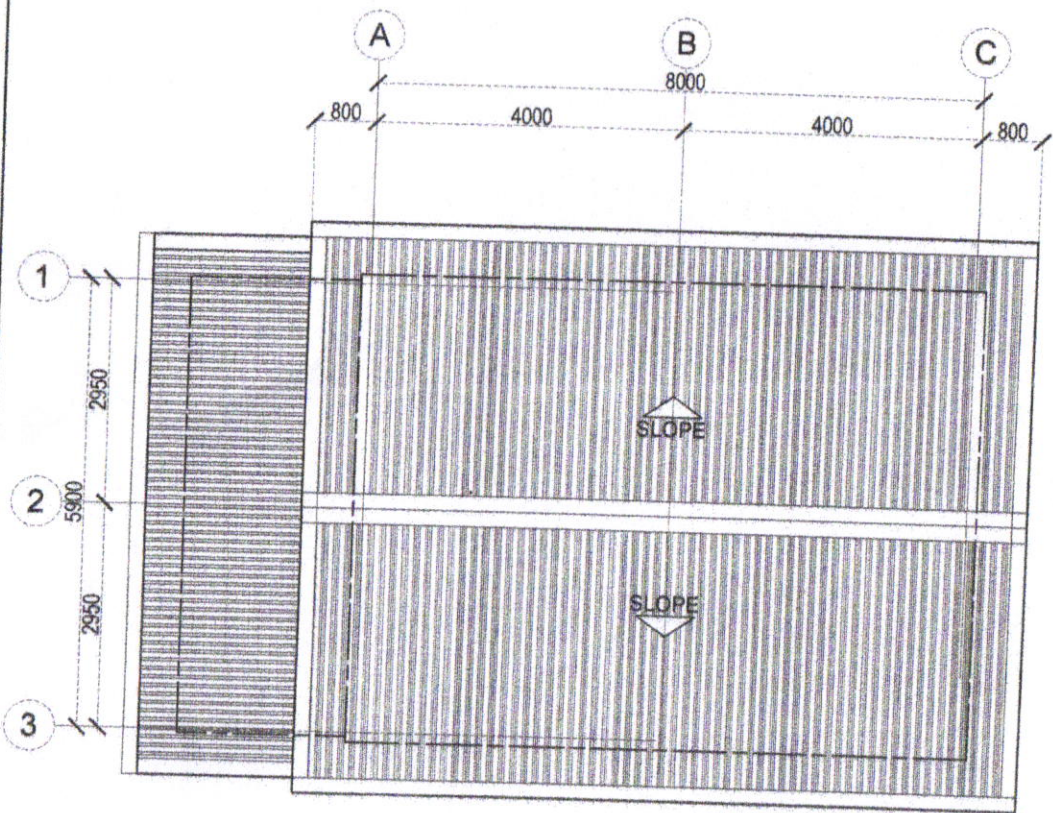

ROOF PLAN
SCALE: 1:100M.

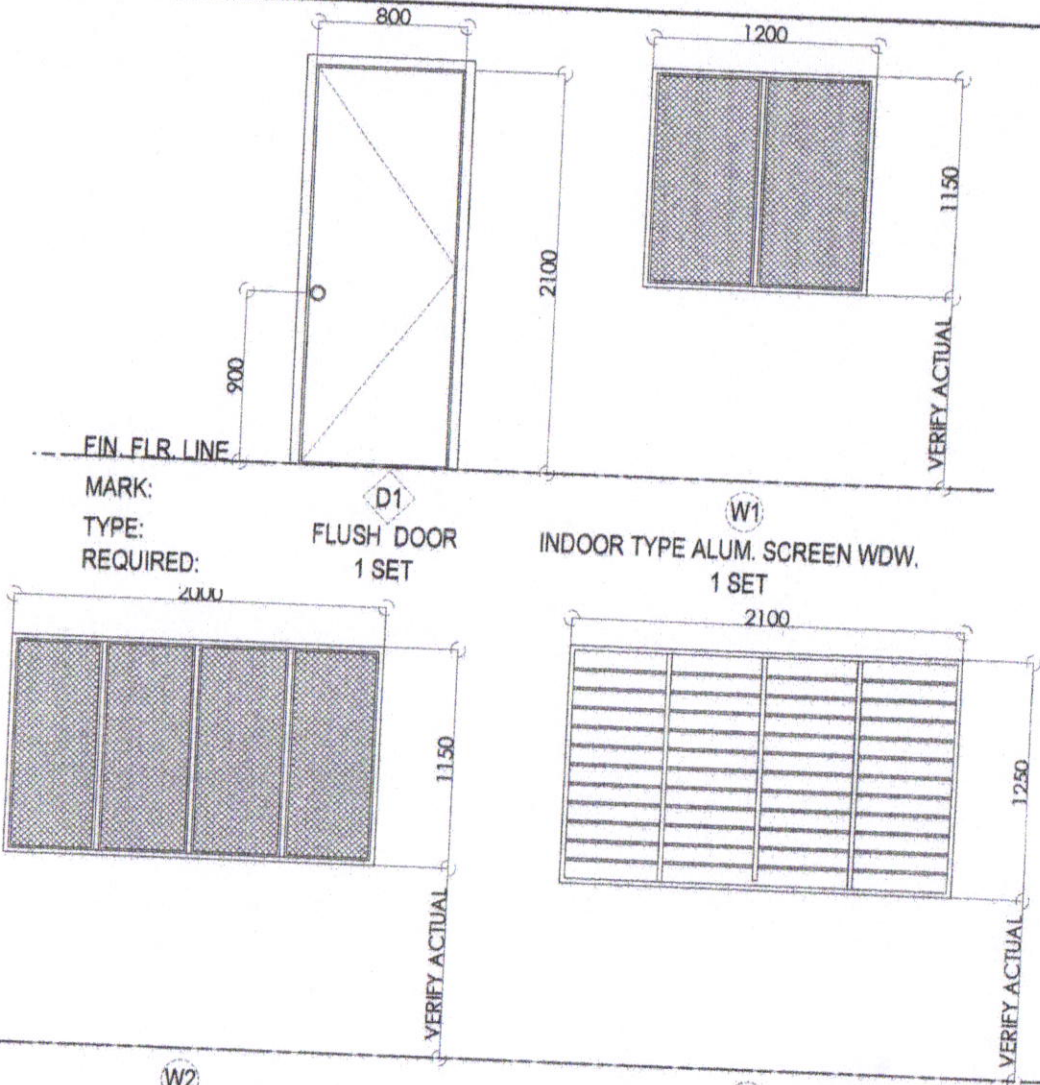

SCHEDULE OF DOORS & WINDOWS
SCALE: 1:40M.

CITY ENGINEER'S OFFICE

SORSOGON CITY
CITY ENGINEER'S OFFICE

PROJECT TITLE:
**CONSTRUCTION/ REPAIR /
IMPROVEMENT OF DAYCARE**
LOCATION: BRGY. SALVACION, BACON DISTRICT, SORSOGON CITY

CADD:
ROWANFARBELLA
DRAFTSMAN III

RECOMMENDED BY:

ROEL D. DIMER, C.E. / RMP
OIC- CITY ENGINEER

APPROVED BY:

HON. MA. ESTER E. HAMOR
CITY MAYOR

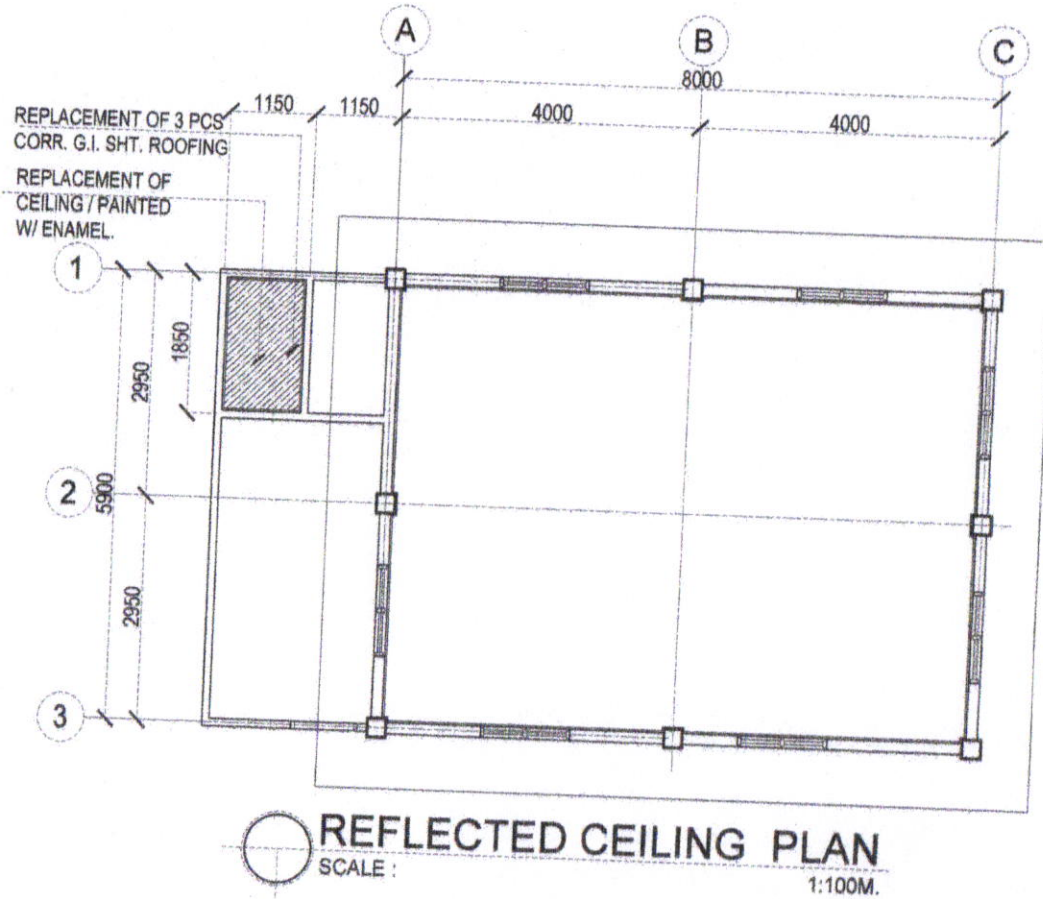
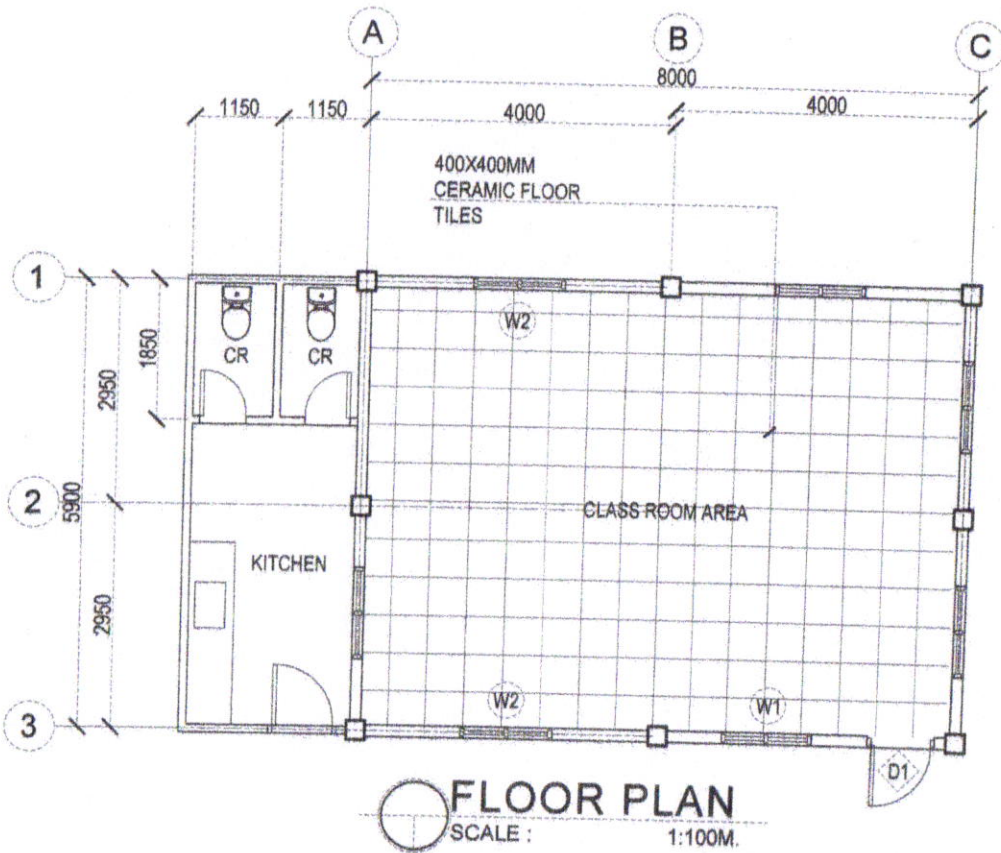

CITY ENGINEER'S OFFICE

SORSOGON CITY
CITY ENGINEER'S OFFICE

PROJECT TITLE:
**CONSTRUCTION/ REPAIR /
IMPROVEMENT OF DAYCARE**

LOCATION: BRGY. SALVACION, BACON DISTRICT, SORSOGON CITY

CADD:

ROWANFARBELLA
DRAFTSMAN III

RECOMMENDED BY:

[Signature]
ROEL D. DOMER, C.E. / RMP
OIC- CITY ENGINEER

APPROVED BY:

HON. MA. ESTER E. HAMOR
CITY MAYOR

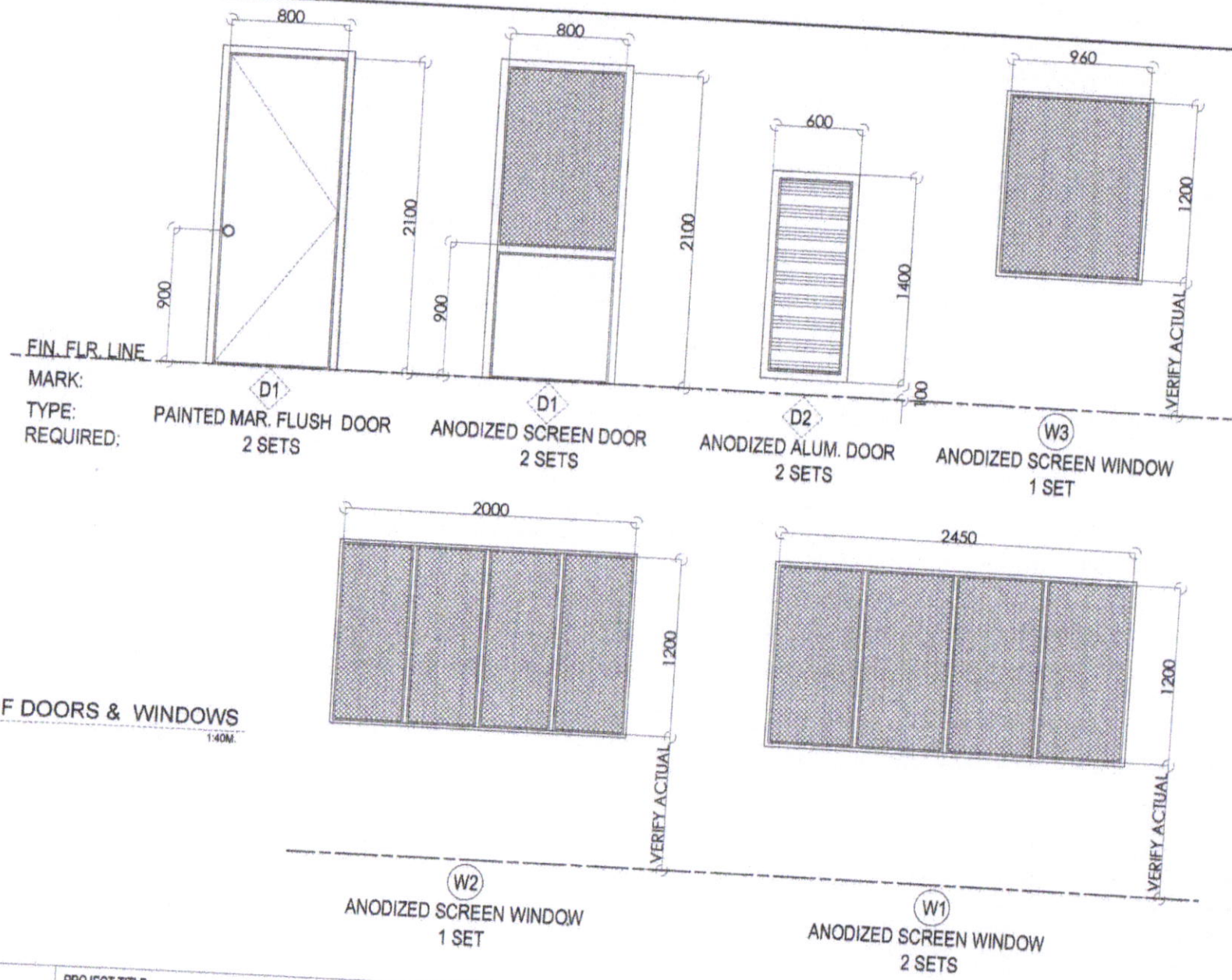

SCHEDULE OF DOORS & WINDOWS
SCALE: 1:40M.

CITY ENGINEER'S OFFICE
SORSOGON CITY
CITY ENGINEER'S OFFICE

PROJECT TITLE: CONSTRUCTION/ REPAIR / IMPROVEMENT OF DAYCARE	CADD: ROWANFARBELLA DRAFTSMAN III	RECOMMENDED BY: ROLD. DOMER C.E. / RMP CIC-CITY ENGINEER	APPROVED BY: HON. MA. ESTER E. HAMOR CITY MAYOR
LOCATION: BRGY. BOGÑA, BACON DISTRICT, SORSOGON CITY			

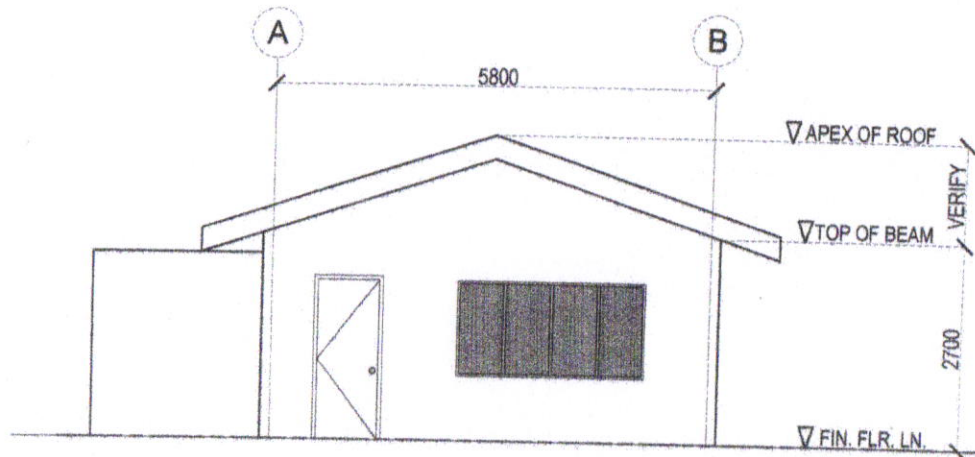

FRONT ELEVATION
SCALE : 1:100M.

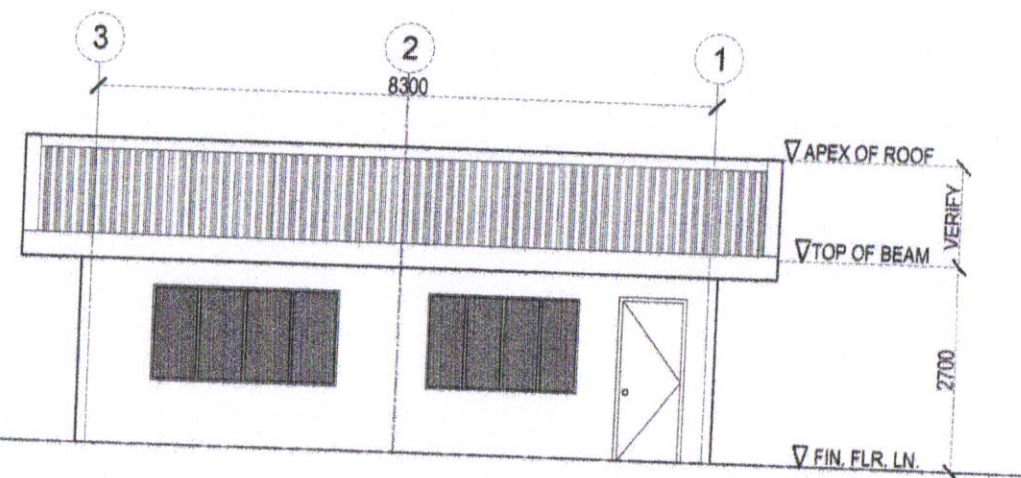

RIGHT SIDE ELEVATION
SCALE : 1:100M.

CITY ENGINEER'S OFFICE

SORSOGON CITY
CITY ENGINEER'S OFFICE

PROJECT TITLE:
**CONSTRUCTION/ REPAIR /
IMPROVEMENT OF DAYCARE**

LOCATION: BRGY. BOGÑA, BACON DISTRICT, SORSOGON CITY

CADD:

ROWANFARBELLA
DRAFTSMAN III

RECOMMENDED BY:

ROEL D. DOMERCE / RMP
OIC- CITY ENGINEER

APPROVED BY:

HON. MA. ESTER E. HAMOR
CITY MAYOR

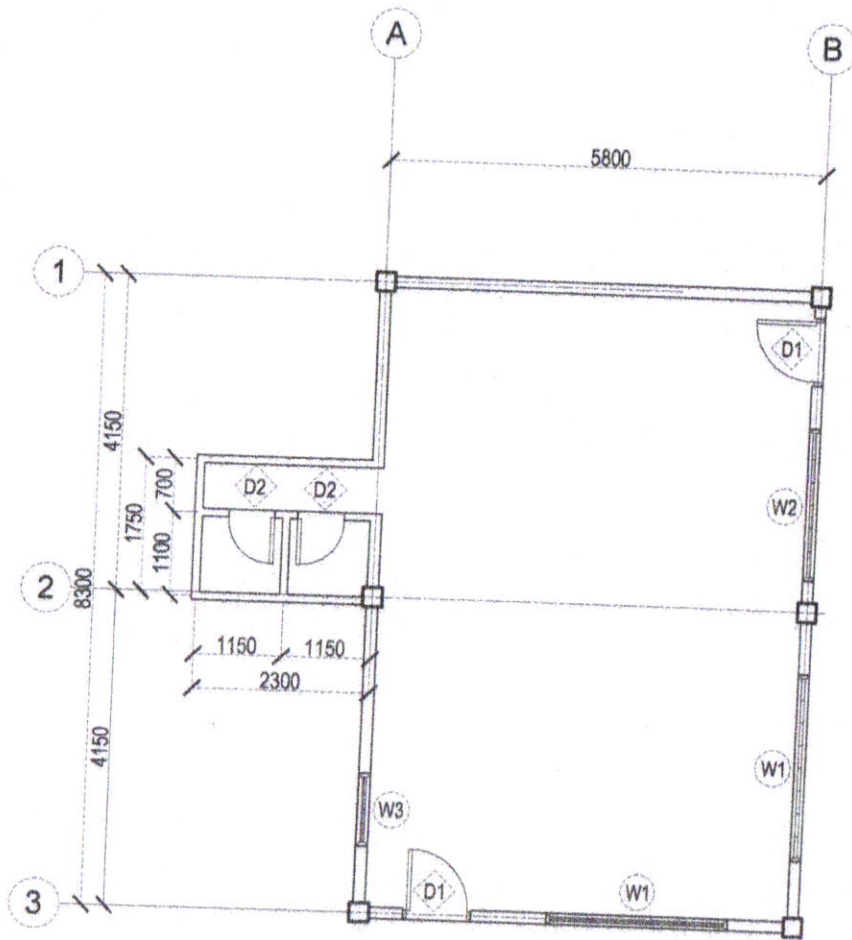

FLOOR PLAN
SCALE : 1:100M.

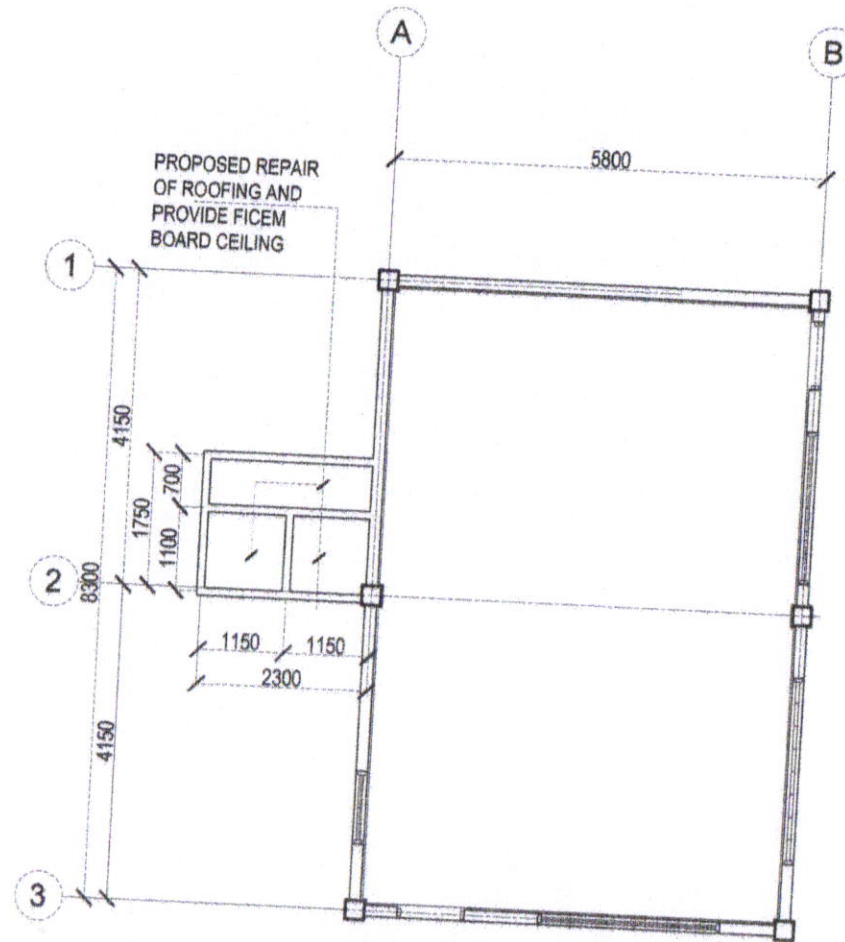

REFLECTED CEILING PLAN
SCALE : 1:100M.

CITY ENGINEER'S OFFICE



SORSOGON CITY
CITY ENGINEER'S OFFICE

PROJECT TITLE:

**CONSTRUCTION/ REPAIR /
IMPROVEMENT OF DAYCARE**

LOCATION: BRGY. BOGÑA, BACON DISTRICT, SORSOGON CITY

CADD:

ROWANFARBELLA
DRAFTSMAN III

RECOMMENDED BY:

ROEL D. DOMER, E.E. / RMP
OIC- CITY ENGINEER

APPROVED BY:

HON. MA. ESTER E. HAMOR
CITY MAYOR

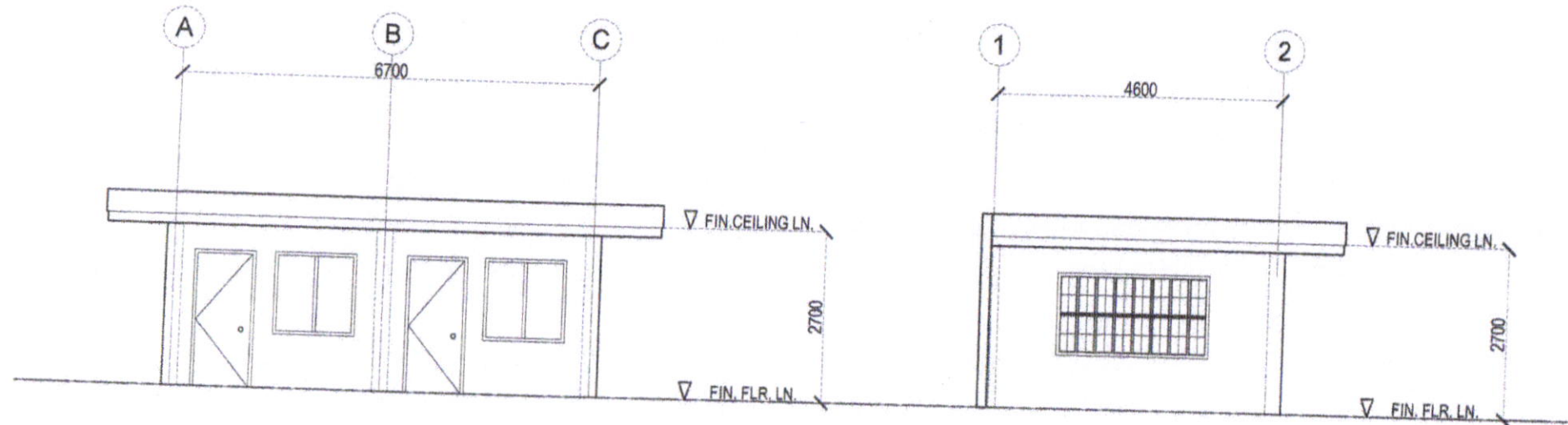

FRONT ELEVATION
SCALE: 1:100M.

LEFT SIDE ELEVATION
SCALE: 1:100M.

PROJECT TITLE:	CADD:	RECOMMENDED BY:	APPROVED BY:
CONSTRUCTION/ REPAIR / IMPROVEMENT OF DAYCARE			
LOCATION: CENTER 1, BRGY. CARICARAN, BACON DISTRICT, SORSOGON CITY.	ROWANFARBELLA DRAFTSMAN III	ROEL D. DOMER C.E. / RMP OIC-CITY ENGINEER	HON. MA. ESTER E. HAMOR CITY MAYOR

CITY ENGINEER'S OFFICE

SORSOGON CITY
CITY ENGINEER'S OFFICE

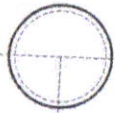

SCHEDULE OF DOORS & WINDOWS

SCALE :

1:40M.

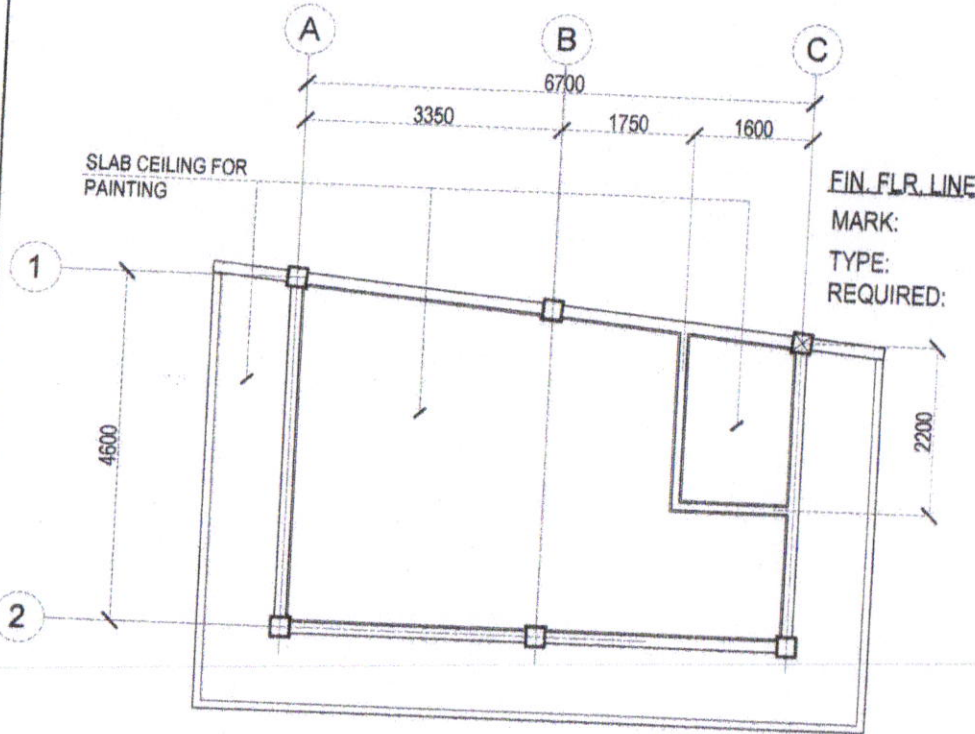
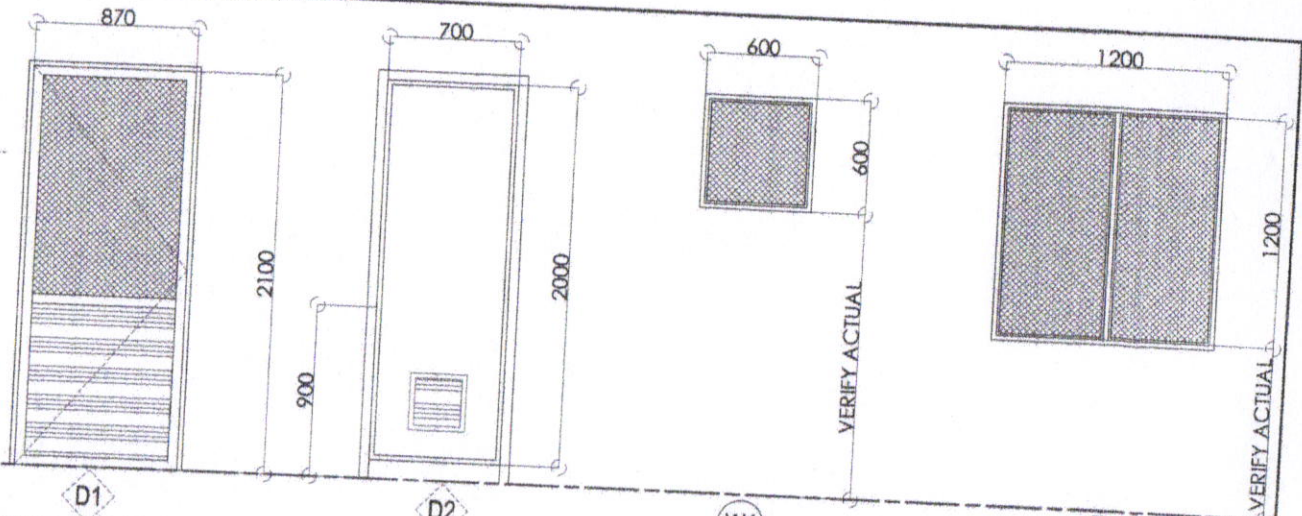

REFLECTED CEILING PLAN

SCALE :

1:100M.

- MARK: TYPE: REQUIRED:
- D1 ANODIZED SCREEN DOOR 2 SETS
 - D2 PVC DOOR 1 SET
 - W4 ANODIZED ALUM. SCREEN WDW. 1 SET
 - W2 ANODIZED SCREEN WINDOW 2 SETS



- W1 ANODIZED SCREEN WINDOW 1 SET
- W3 ANODIZED SCREEN WINDOW 1 SET

CITY ENGINEER'S OFFICE



SORSOGON CITY
CITY ENGINEER'S OFFICE

PROJECT TITLE:

**CONSTRUCTION/ REPAIR /
IMPROVEMENT OF DAYCARE**

LOCATION: CENTER 1, BRGY. CARICARAN, BACON DISTRICT, SORSOGON CITY.

CADD:

ROWANFARBELLA
DRAFTSMAN III

RECOMMENDED BY:

ROEL O. DOMERCE / RMP
OIC- CITY ENGINEER

APPROVED BY:

HON. MA. ESTER E. HAMOR
CITY MAYOR

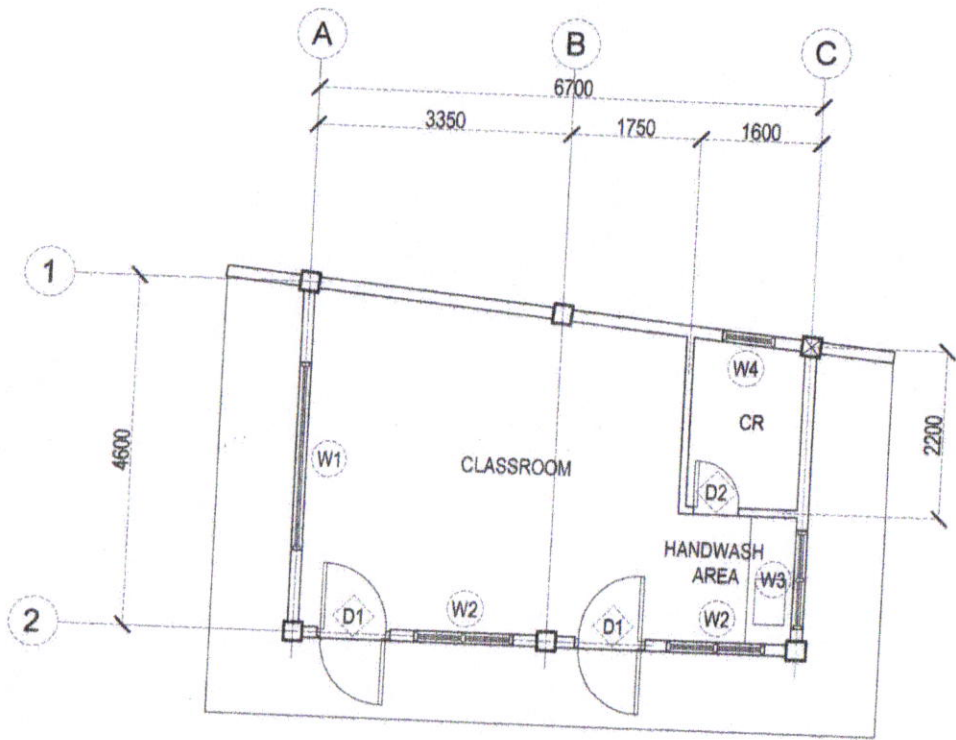

FLOOR PLAN
SCALE : 1:100M.

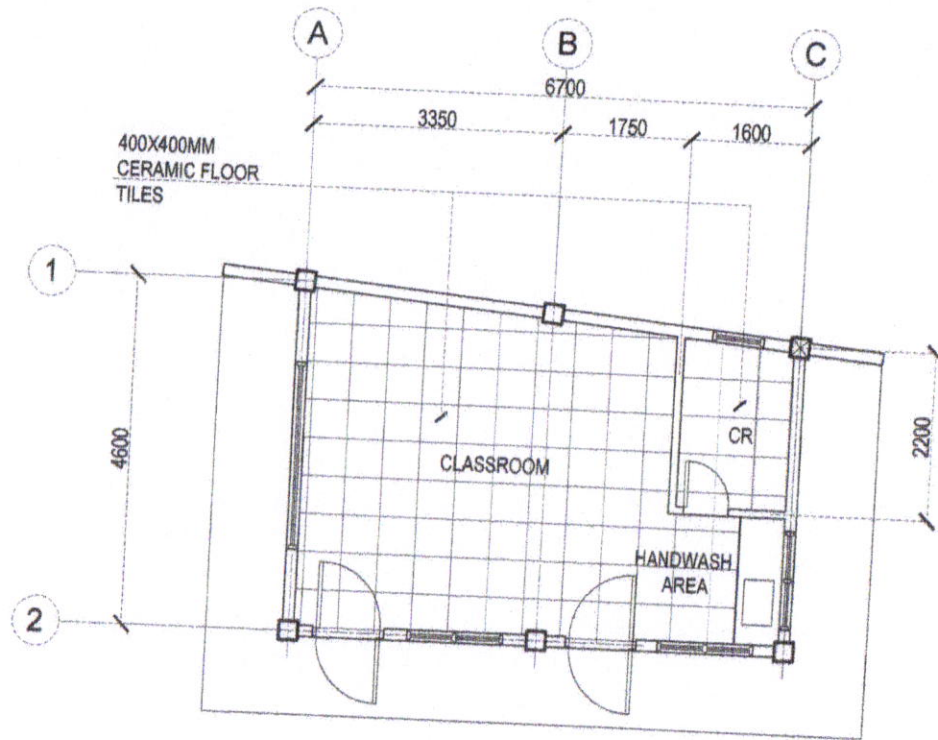

FLOOR TILES LAY OUT PLAN
SCALE : 1:100M.

CITY ENGINEER'S OFFICE



SORSOGON CITY
CITY ENGINEER'S OFFICE

PROJECT TITLE:

**CONSTRUCTION/ REPAIR /
IMPROVEMENT OF DAYCARE**

LOCATION: CENTER 1, BRGY. CARICARAN, BACON DISTRICT, SORSOGON CITY.

CADD:

ROWANFARBELLA
DRAFTSMAN III

RECOMMENDED BY:

ROEL D. DOMER, C.E. / RMP
OIC-CITY ENGINEER

APPROVED BY:

HON. MA. ESTER E. HAMOR
CITY MAYOR

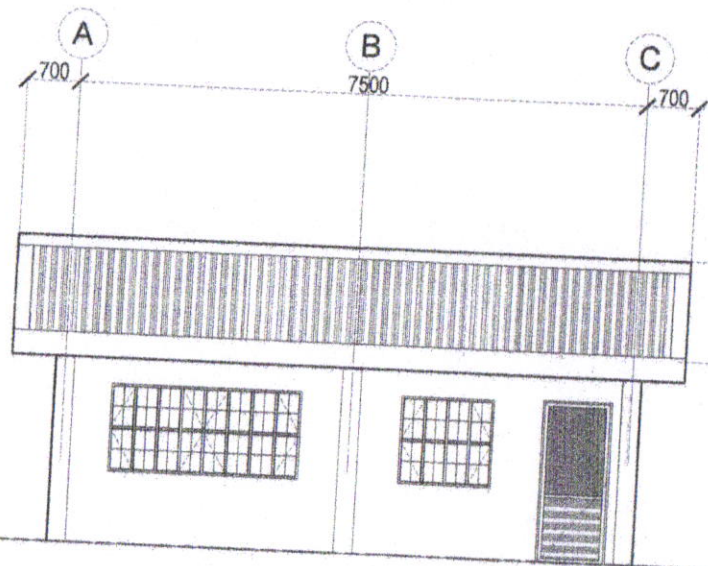

FRONT ELEVATION
SCALE : 1:100M.

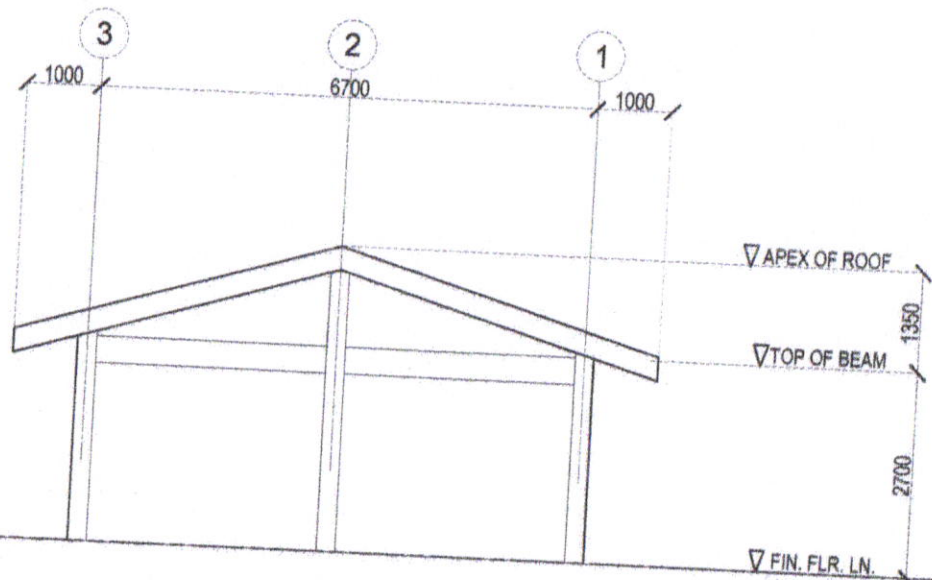

RIGHT SIDE ELEVATION
SCALE : 1:100M.

PREPARED FROM:

PROJECT TITLE:

CADD:

RECOMMENDED BY:

APPROVED BY:

**CONSTRUCTION/ REPAIR /
IMPROVEMENT OF DAYCARE**

LOCATION: BRGY. SAN VICENTE, BACON DISTRICT, SORSOGON CITY.

ROWANFARBELLA
DRAFTSMAN III

ROEL B. DOMERIO, RMP
OIC- CITY ENGINEER

HON. MA. ESTER E. HAMOR
CITY ENGINEER



**SORSOGON CITY
CITY ENGINEER'S OFFICE**

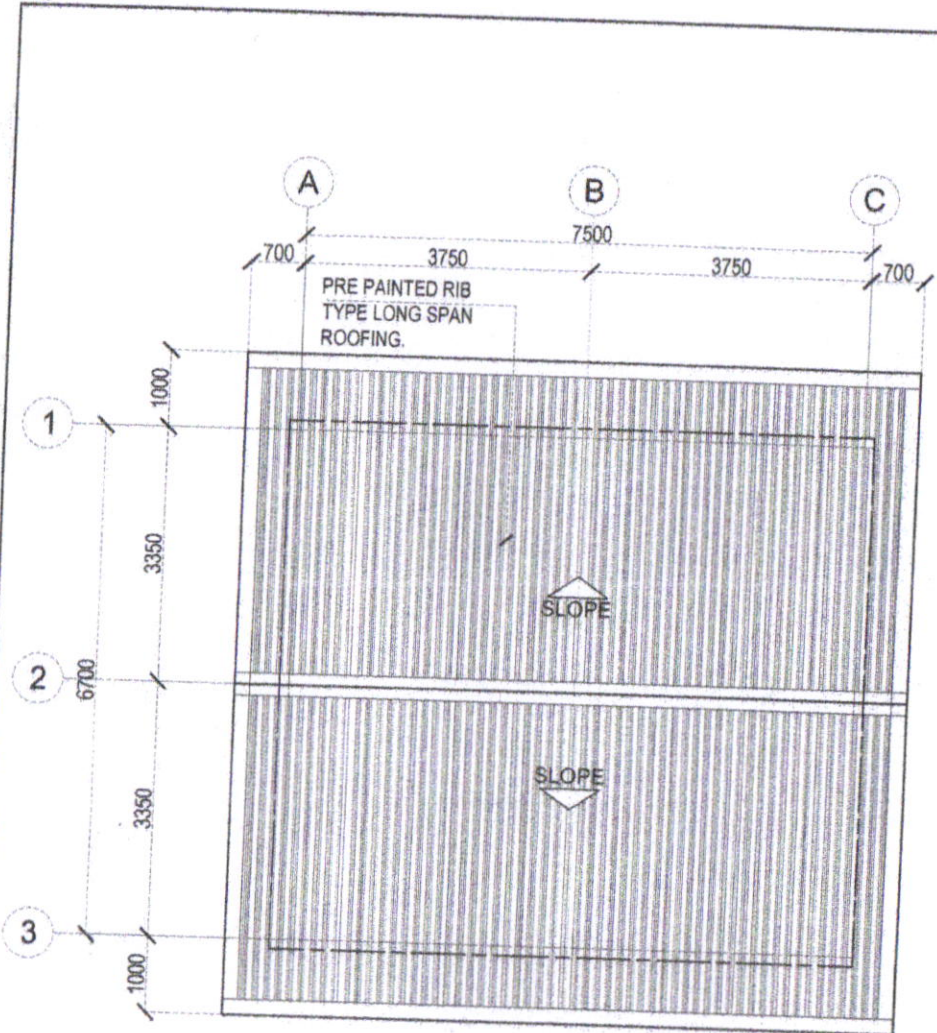

ROOF PLAN
SCALE: 1:100M.

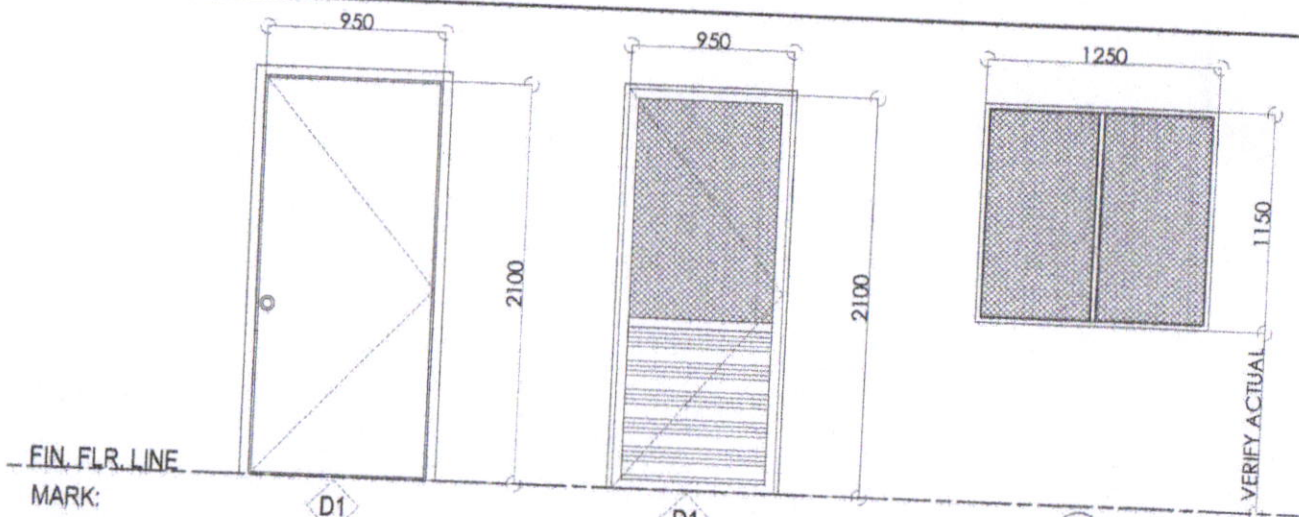

FIN. F.L.R. LINE
 MARK: D1 D1 W2
 TYPE: FLUSH DOOR ANODIZED SCREEN DOOR ANODIZED SCREEN WINDOW
 REQUIRED: 1 SET 1 SET 2 SETS

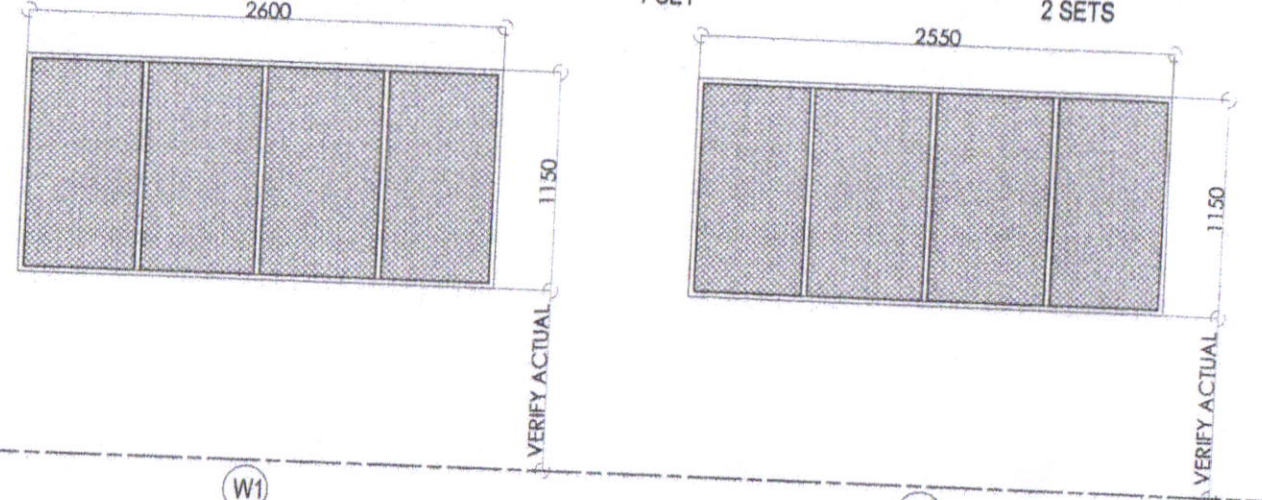

W1 ANODIZED SCREEN WINDOW 1 SET
 W2 ANODIZED SCREEN WINDOW 1 SET

SCHEDULE OF DOORS & WINDOWS
SCALE: 1:40M.

PREPARED FROM:	PROJECT TITLE:	CADD:	RECOMMENDED BY:	APPROVED BY:
 SORSOGON CITY CITY ENGINEER'S OFFICE	CONSTRUCTION/ REPAIR / IMPROVEMENT OF DAYCARE			
	LOCATION: BRGY. SAN VICENTE, BACON DISTRICT, SORSOGON CITY.	ROWANFMARBELLA DRAFTSMAN III	ROEL D. DOMER C.E. / RMP OIC- CITY ENGINEER	HON. MA. ESTER E. HAMOR CITY MAYOR

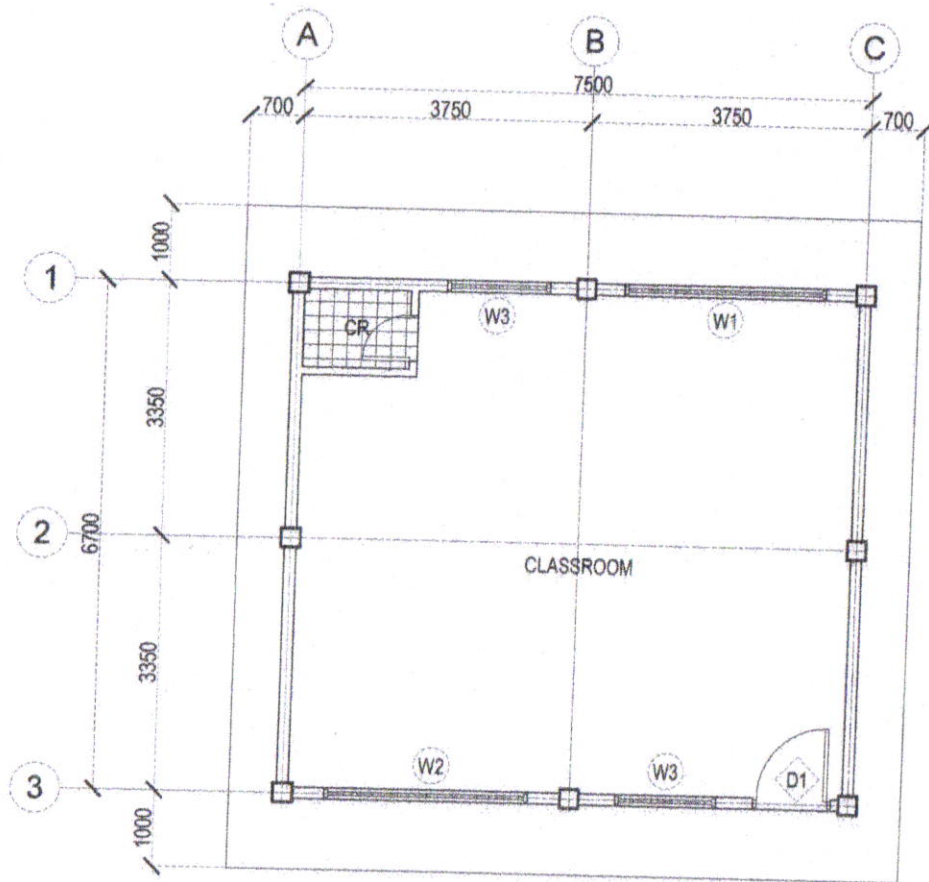

FLOOR PLAN
SCALE : 1:100M.

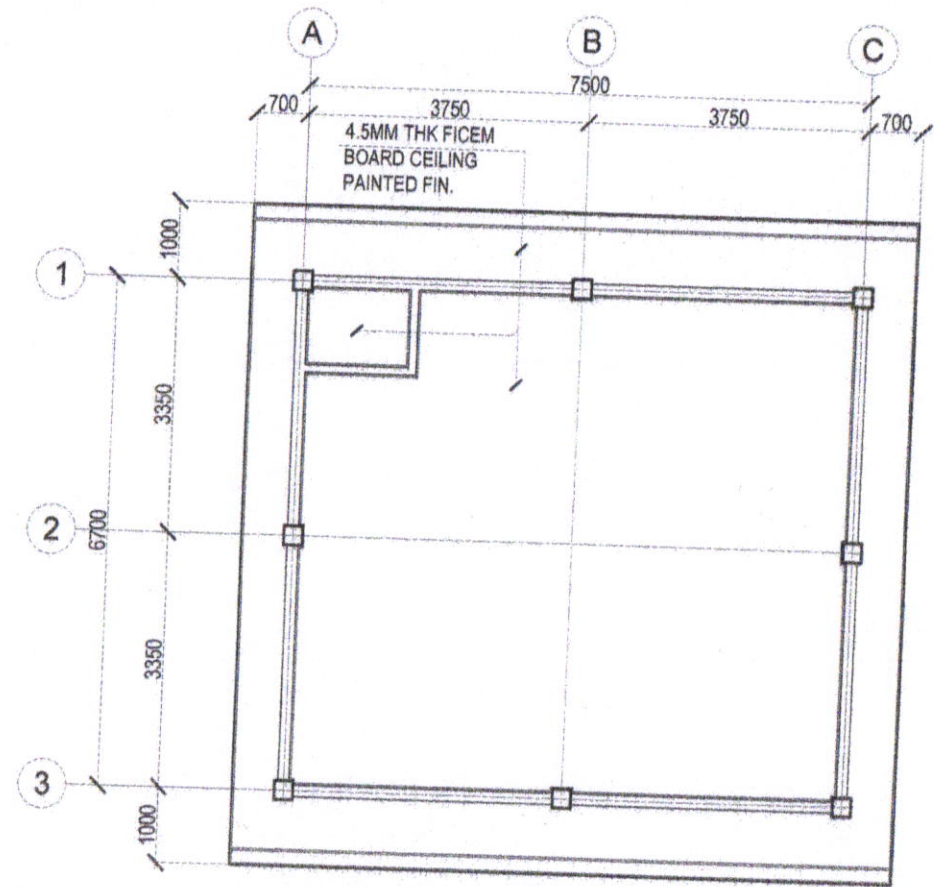

REFLECTED CEILING PLAN
SCALE : 1:100M.

PREPARED FROM:	PROJECT TITLE:	CADD:	RECOMMENDED BY:	APPROVED BY:
 <p>SORSOGON CITY CITY ENGINEER'S OFFICE</p>	CONSTRUCTION/ REPAIR / IMPROVEMENT OF DAYCARE			
	LOCATION: BRGY. SAN VICENTE, BACON DISTRICT, SORSOGON CITY.	ROWANFMARBELLA DRAFTSMAN III	ROEL F. DOMER, C.E. / RMP OIC- CITY ENGINEER	HON. MA. ESTER E. HAMOR CITY MAYOR

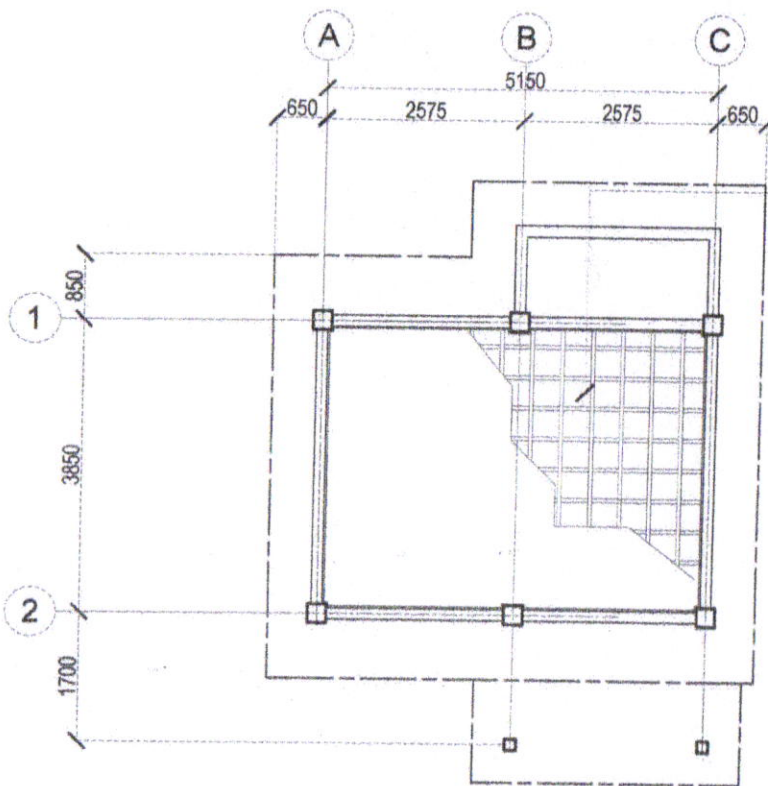

4.8MM THK FICEM BOARD ON METAL FURRING CEILING JOIST SPACED @ 400MM ON CENTER BOTHWAYS.

REFLECTED CEILING PLAN
SCALE: 1:100M.

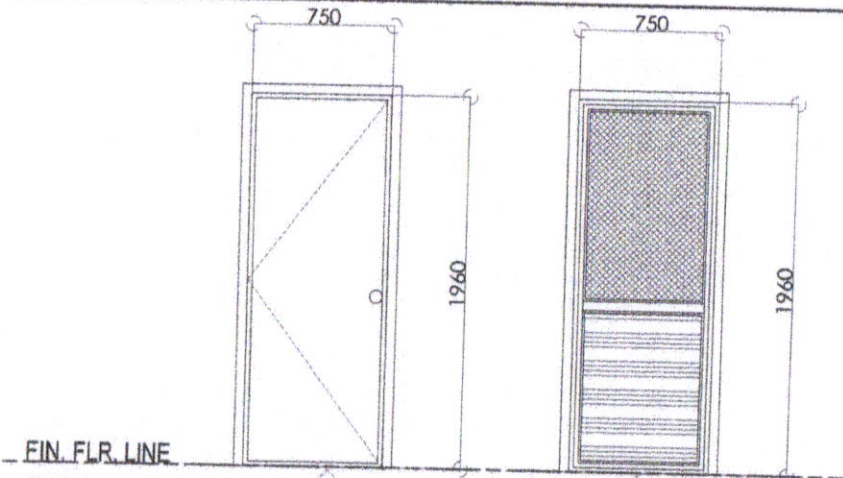

FIN. FLR. LINE
 MARK: D1 D1
 TYPE: FLUSH DOOR ANODIZED SCREEN DOOR
 REQUIRED: 1 SET 1 SET



FIN. FLR. LINE
 MARK: W1 W2
 TYPE: ANODIZED SCREEN WINDOW ANODIZED SCREEN WINDOW
 REQUIRED: 1 SET 1 SETS

SCHEDULE OF DOORS & WINDOWS
SCALE: 1:40M.

PREPARED FROM:	PROJECT TITLE:	CADD:	RECOMMENDED BY:	APPROVED BY:
 SORSOGON CITY CITY ENGINEER'S OFFICE	CONSTRUCTION/ REPAIR / IMPROVEMENT OF DAYCARE			
	LOCATION: PUROK 1, BRGY. SAN JOSE, BACON DISTRICT, SORSOGON CITY.	ROWANFARBELLA DRAFTSMAN III	ROEL B. DOMER C.E. // RMP OIC- CITY ENGINEER	HON. MA. ESTER E. HAMOR CITY MAYOR

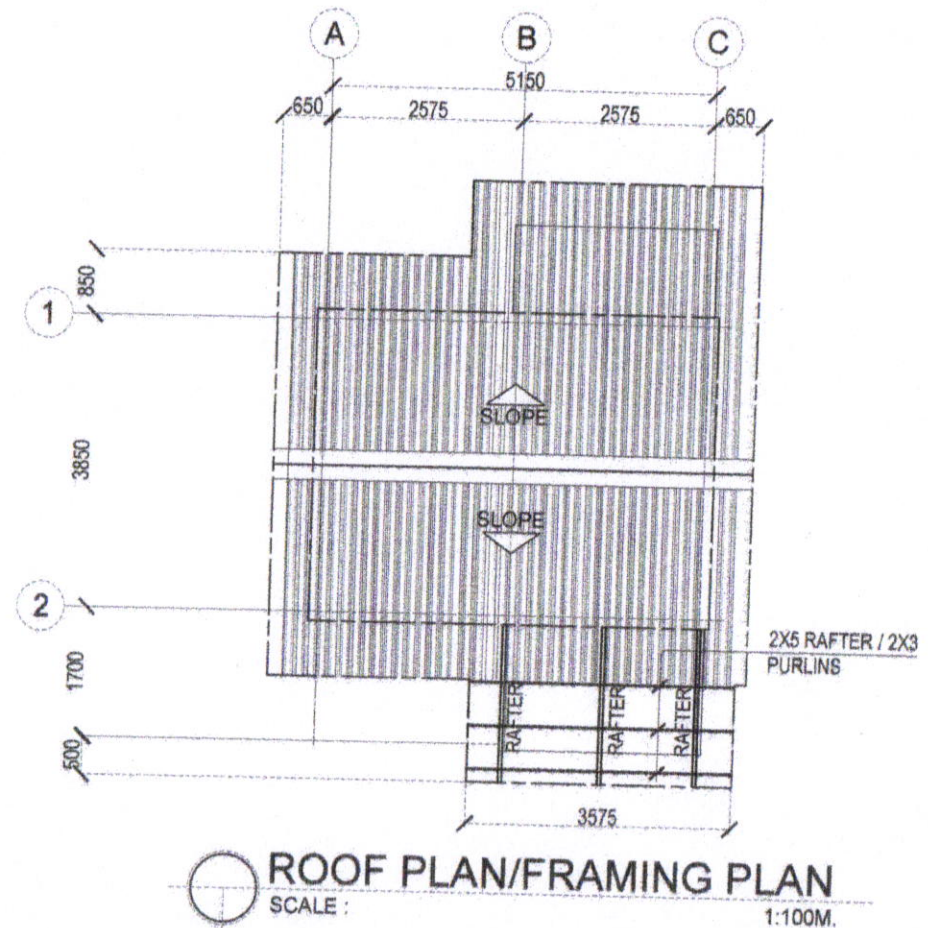
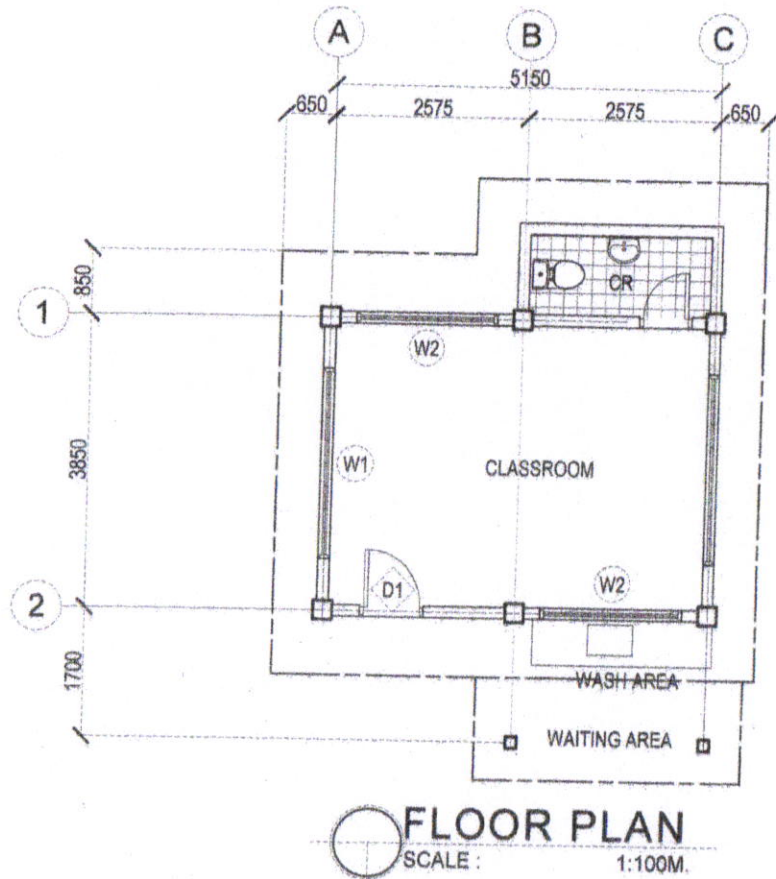

PREPARED FROM:	PROJECT TITLE:	CADD:	RECOMMENDED BY:	APPROVED BY:
 SORSOGON CITY CITY ENGINEER'S OFFICE	CONSTRUCTION/ REPAIR / IMPROVEMENT OF DAYCARE			
	LOCATION: PUROK 1, BRGY. SAN JOSE, BACON DISTRICT, SORSOGON CITY.	ROWANFMARBELLA DRAFTSMAN III	ROEL D. DOMERALE / RMP OIC-CITY ENGINEER	HON. MA. ESTER E. HAMOR CITY MAYOR

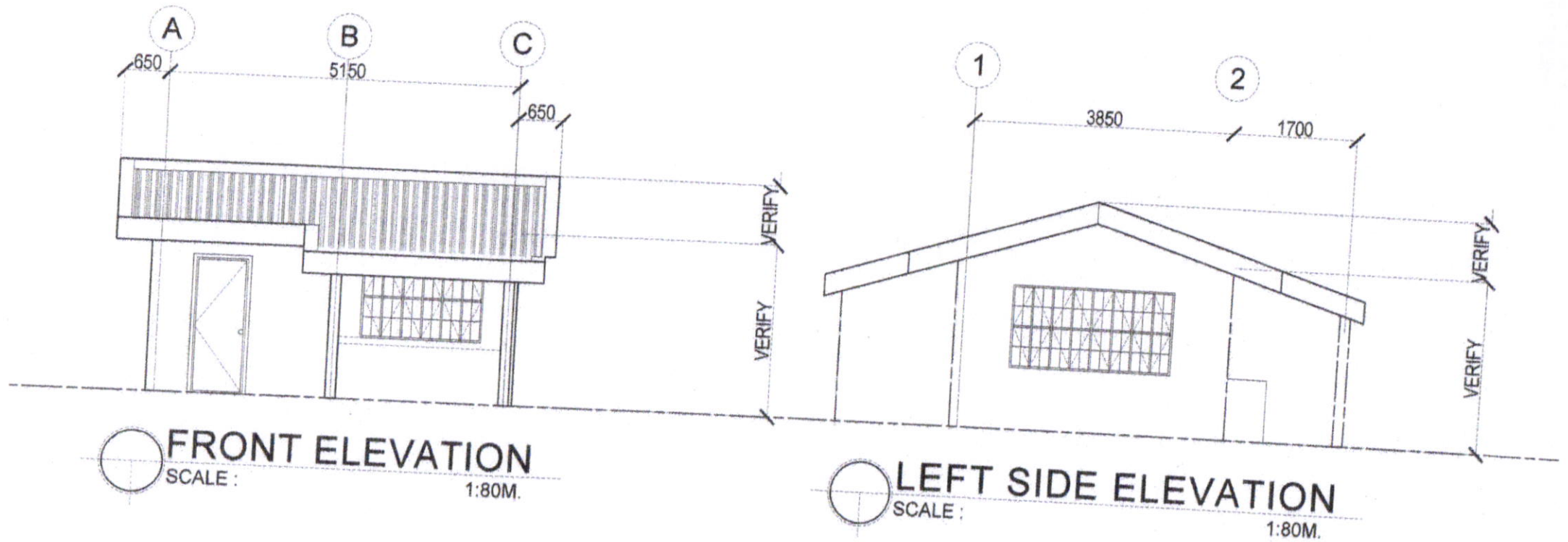

PREPARED FROM:

CITY ENGINEER'S OFFICE



SORSOGON CITY
CITY ENGINEER'S OFFICE

PROJECT TITLE:

CONSTRUCTION/ REPAIR /
IMPROVEMENT OF DAYCARE

CADD:

ROWANFARBELLA
DRAFTSMAN III

RECOMMENDED BY:

ROGER D. DOMER, C.E. / RMP
OIC-CITY ENGINEER

APPROVED BY:

HON. MA. ESTER E. HAMOR
CITY MAYOR

LOCATION: PUROK 1, BRGY. SAN JOSE, BACON DISTRICT, SORSOGON CITY.

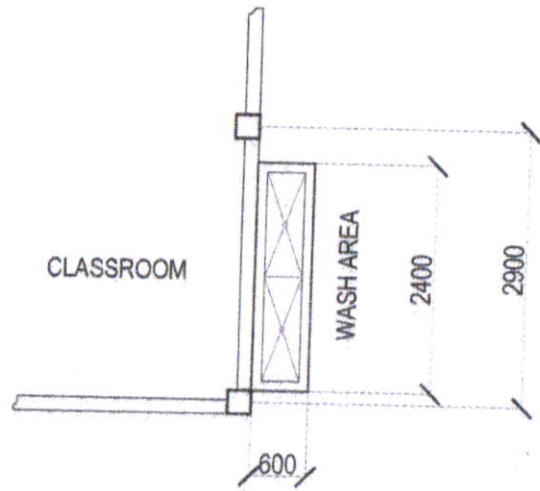

FLOOR PLAN
SCALE: 1:80M.

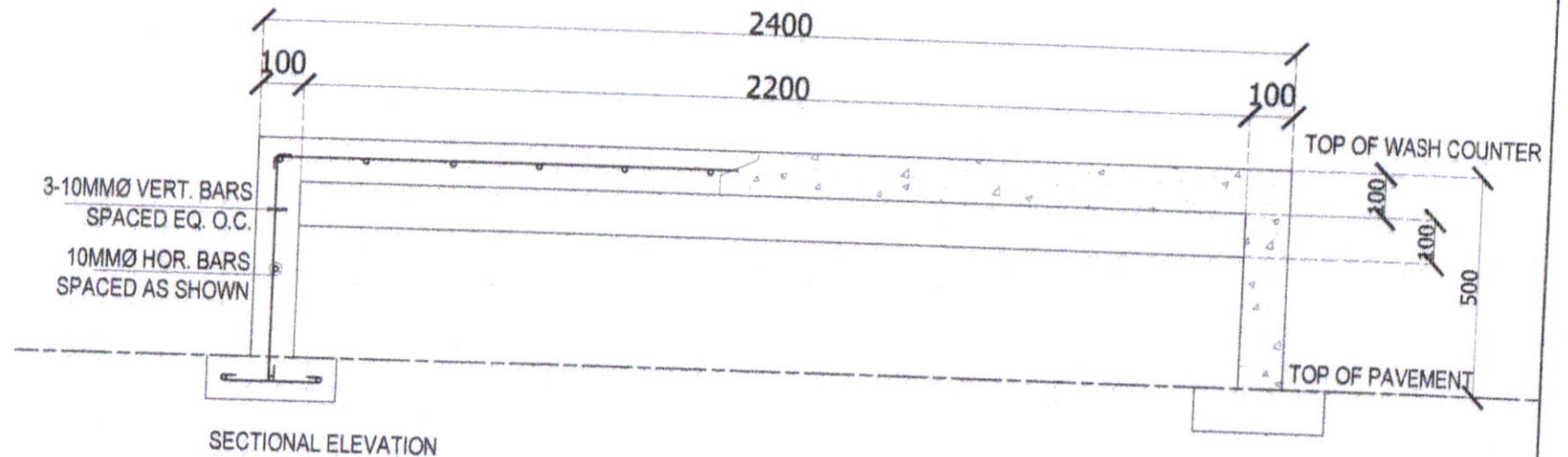
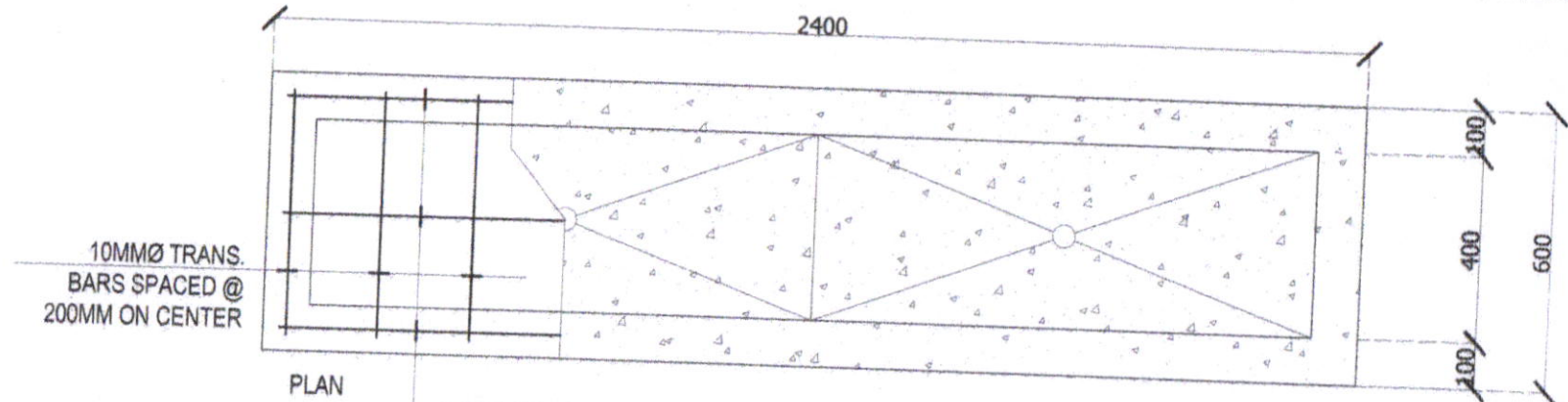

DETAIL OF HANDWASH COUNTER
SCALE: 1:16M.

PREPARED FROM:	PROJECT TITLE:	CADD:	RECOMMENDED BY:	APPROVED BY:
 SORSOGON CITY CITY ENGINEER'S OFFICE	CONSTRUCTION/ REPAIR / IMPROVEMENT OF DAYCARE			
	LOCATION: PUROK 4, BRGY. SAN JOSE, BACON DISTRICT, SORSOGON CITY.	ROWANFARBELLA DRAFTSMAN III	ROEL D. DOMER, C.E. / RMP CIC-CITY ENGINEER	HON. MA. ESTER E. HAMOR CITY MAYOR